

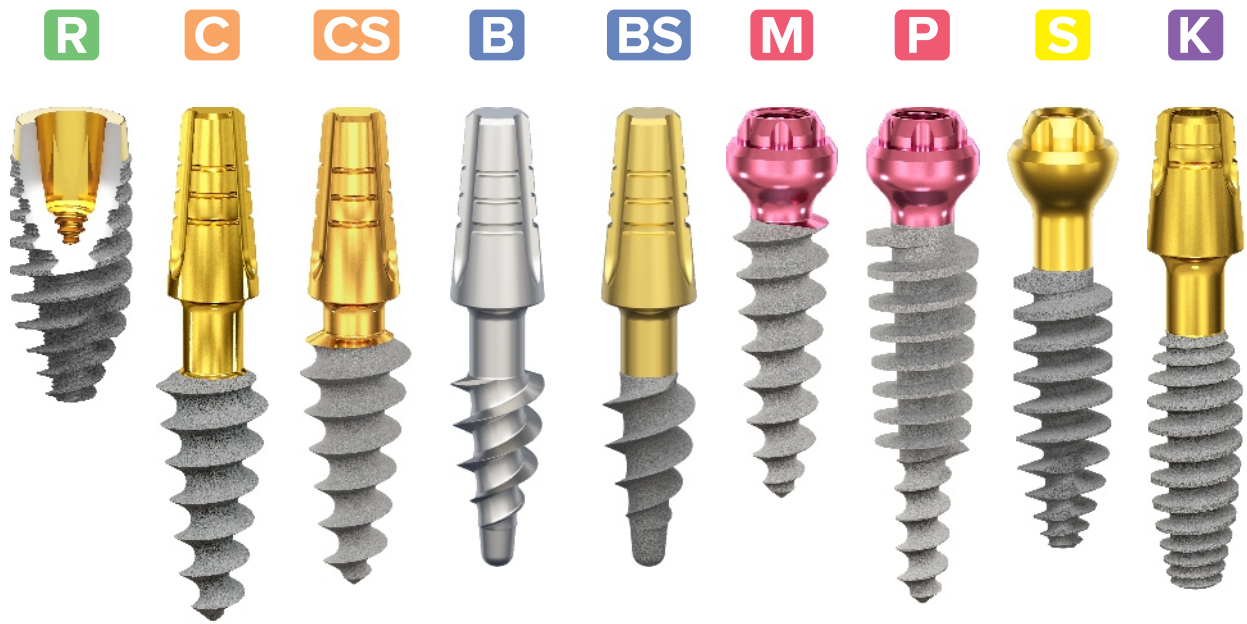

ROOTT



System overview

Excellent 5 years clinical evidence with ROOTT implants

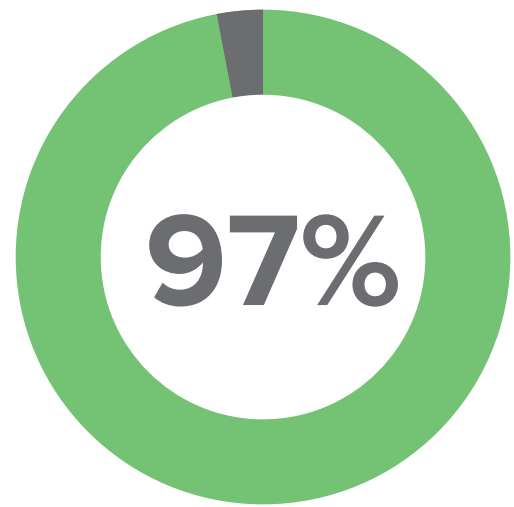

Average survival rate

The post-market clinical follow-up study showed a significantly high average survival rate of 97.86% of the entire ROOTT Dental Implant System.

Report from 2021-05-24

High quality and safety standards

Medical devices under this catalog are in compliance with established EU regulatory requirements.

Confidence with traditional approach



Cement



Screw



Telescopic

ROOTT R

Minimally invasive alternatives



Cement



Screw



Telescopic

ROOTT C CS
B BS
P M S
K

ROOTT **R**

Cement & screw retained

Two-piece implant

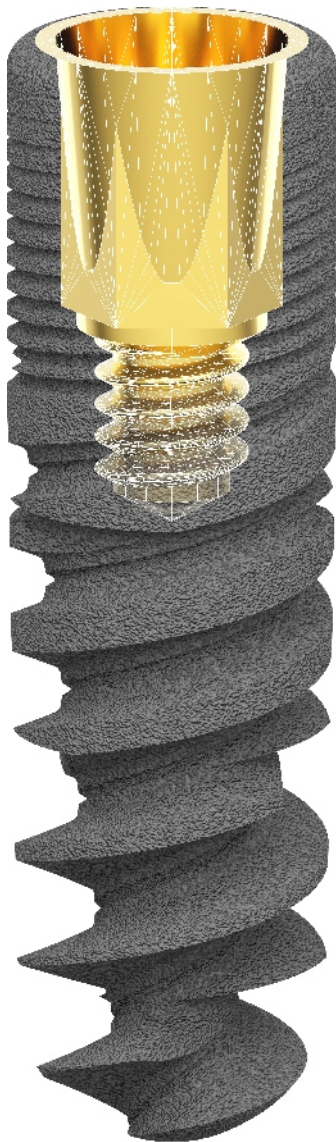

- Multiple and single restorations.
- Immediate & delayed placement.

* Use CRE as a support when forming a healing abutment with composite.

Single platform

- 10° 10° cone & internal hex
- Secure connection
- No microgap / no micromovement

Primary stability

- V-shape design
Efficient insertion
- RBM blasted, acid etched surface
Optimum adhesion
- Variable threads
Bone condensation

1 package – does it all

- Healing abutment *
- Regular abutment
- Direct scan
- Transfer



Multiple possibilities

ROOTT R

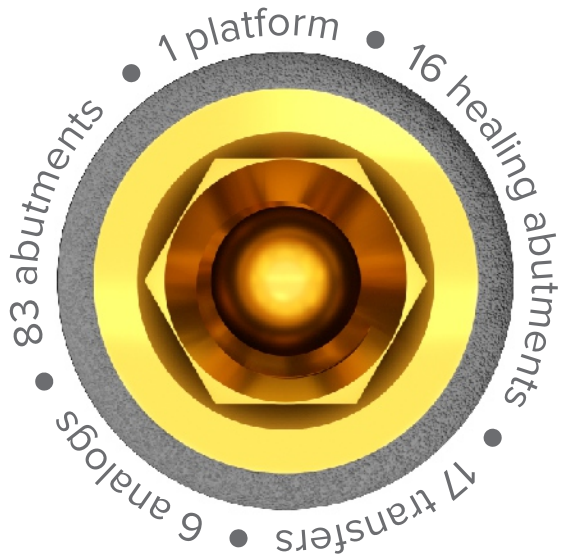

Freedom and flexibility with switching platform and morse taper connection for all prosthetic components & all implant sizes of

Ø: 3.0–5.5mm
L: 6–16mm

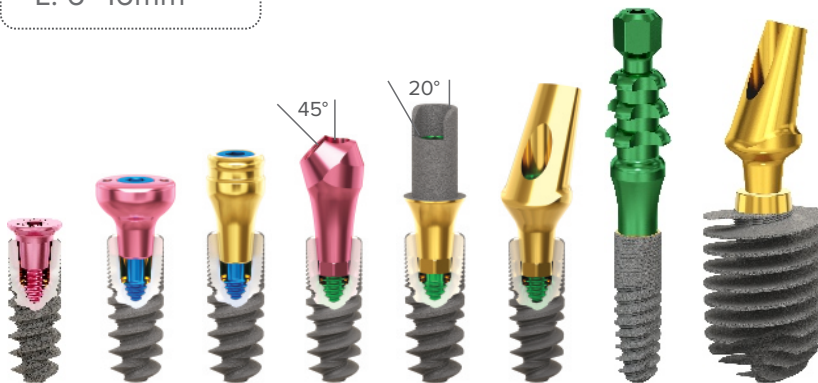

Easy management

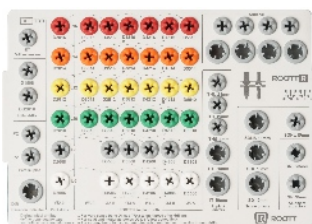

TRR



TRR-mini

Clinical cases



By Dr. Mohamad El Moheb



By Dr. Roman Novichenko



More cases



ROOTT **R**

M1.6x0.35 6H

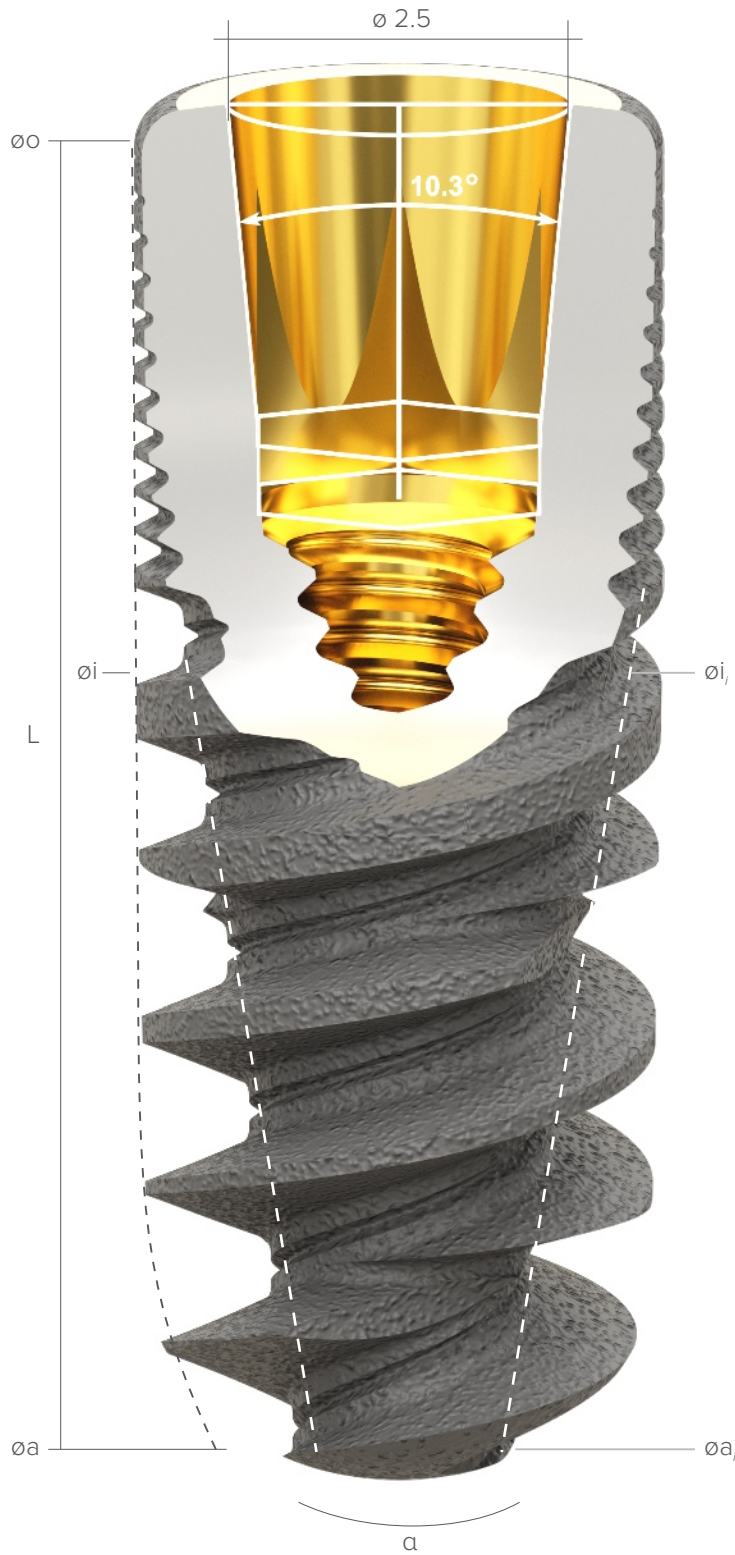

$\varnothing o$ - occlusal diameter (mm); $\varnothing i$ - intraosseous diameter (mm); $\varnothing a$ - apical diameter (mm);
 α - total internal angle ($^{\circ}$); s - intraosseous square area (mm^2); i = internal.

ø 3.0

ø 3.5

ø 3.8

ø 4.2

ø 4.8

o / L

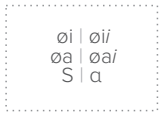

Ti6Al4V ELI

R3506

3.5 | 3.3
3.4 | 1.8
85 | 24



R3806

3.8 | 3.4
3.7 | 1.6
95 | 28



R4206

4.2 | 3.4
3.4 | 2.0
109 | 26.6



R4806

4.8 | 3.9
3.6 | 1.8
132 | 38.5



6 mm

R3508

3.5 | 3.3
3.4 | 1.7
111 | 20



R3808

3.8 | 3.4
3.7 | 1.3
128 | 21



R4208

4.2 | 3.4
3.4 | 2.0
151 | 21.7



R4808

4.8 | 3.9
3.6 | 1.8
179 | 38.5



8 mm

R3010

3.0 | 2.5
2.8 | 1.4
114 | 14



R3510

3.5 | 3.2
3.3 | 0.8
137 | 21



R3810

3.8 | 3.4
3.6 | 1.2
159 | 15



R4210

4.2 | 2.8
1.7 | 1.0
165 | 20.1



R4810

4.8 | 3.2
1.4 | 1.0
196 | 40



10 mm

R3012

3.0 | 2.5
2.7 | 1.4
137 | 10



R3512

3.4 | 3.2
3.3 | 0.7
164 | 17



R3812

3.7 | 3.4
3.6 | 1.2
190 | 12



R4212

4.2 | 2.7
1.7 | 1.0
211 | 16.4



R4812

4.8 | 3.2
1.7 | 1.0
248 | 40



12 mm

R3014

3.0 | 2.5
2.5 | 1.4
159 | 7.5



R3514

3.4 | 3.2
3.2 | 0.7
188 | 14



R3814

3.7 | 3.4
3.5 | 1.1
220 | 10



R4214

4.2 | 2.7
1.7 | 1.0
255 | 13.9



R4814

4.8 | 3.2
1.7 | 1.0
302 | 40



14 mm

R3016

2.9 | 2.4
2.4 | 1.4
178 | 6



R3516

3.3 | 3.2
3.1 | 0.6
215 | 12



R3816

3.6 | 3.4
3.4 | 1.0
249 | 9



R4216

4.2 | 2.8
1.7 | 1.0
303 | 12.0



R4816

4.8 | 3.2
1.7 | 1.0
355 | 40



16 mm

ROOTT **R**



o - occlusal diameter (mm); i - intraosseous diameter (mm); a - apical diameter (mm);
 α - total internal angle (°); s - intraosseous square area (mm²); i = internal.

∅ 5.5

∅ 6.5

∅ 7.5

∅ 8.5

o / L

R5506

5.5 | 3.9
4.1 | 1.8
167 | 38.5



R6506

6.5 | 3.9
4.1 | 1.8
226 | 38.5



R7506

7.5 | 3.9
4.1 | 1.8
302 | 38.5



R8506

8.5 | 3.9
4.1 | 1.8
381 | 38.5



6 mm

R5508

5.5 | 3.9
4.1 | 1.8
230 | 38.5



R6508

6.5 | 4.0
4.1 | 1.8
317 | 38.5



R7508

7.5 | 4.0
4.1 | 1.8
431 | 38.5



R8508

8.5 | 4.0
4.1 | 1.8
550 | 38.5



8 mm

R5510

5.5 | 3.2
1.7 | 1.0
246 | 40



R6510

6.5 | 3.5
3.8 | 1.0
338 | 40



R7510

7.5 | 3.5
3.8 | 1.0
456 | 40



R8510

8.5 | 3.5
3.8 | 1.0
566 | 38.5



10 mm

R5512

5.5 | 3.2
1.7 | 1.0
315 | 40



R6512

6.5 | 3.5
3.8 | 1.0
435 | 40



R7512

7.5 | 3.5
3.8 | 1.0
591 | 40



R8512

8.5 | 3.5
3.8 | 1.0
741 | 40



12 mm

R5514

5.5 | 3.2
1.7 | 1.0
385 | 40



R6514

6.5 | 3.6
3.8 | 1.0
533 | 40



R7514

7.5 | 3.6
3.8 | 1.0
726 | 40



R8514

8.5 | 3.6
3.8 | 1.0
917 | 40



14 mm

R5516

5.5 | 3.2
1.7 | 1.0
454 | 40



16 mm

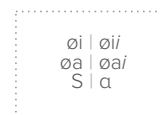

Ti6Al4V ELI

Healing abutments



Instructions

Bone build-up

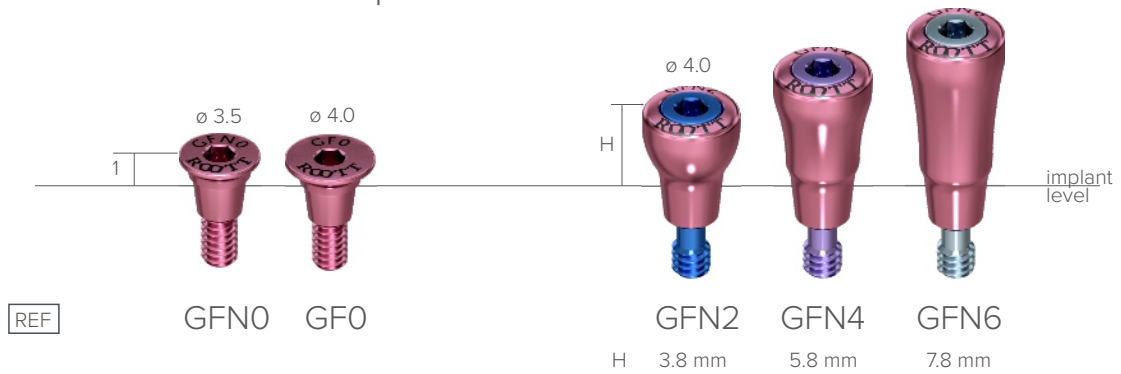

Regular

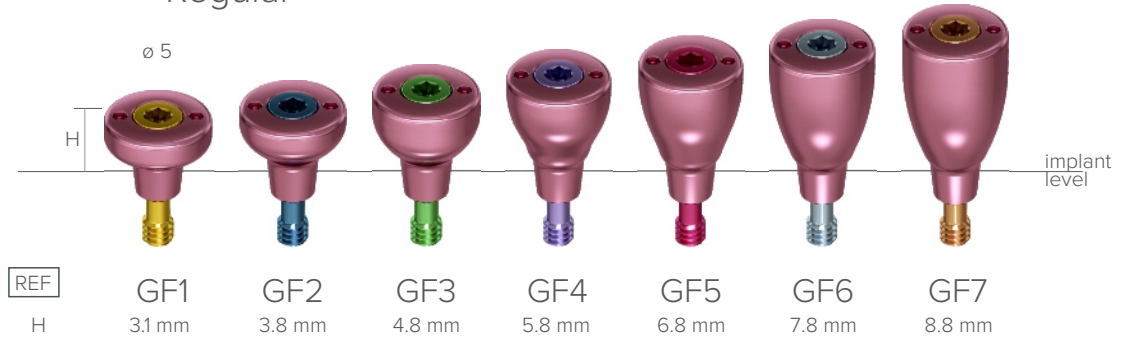

One-piece



Transfers & implant analogs

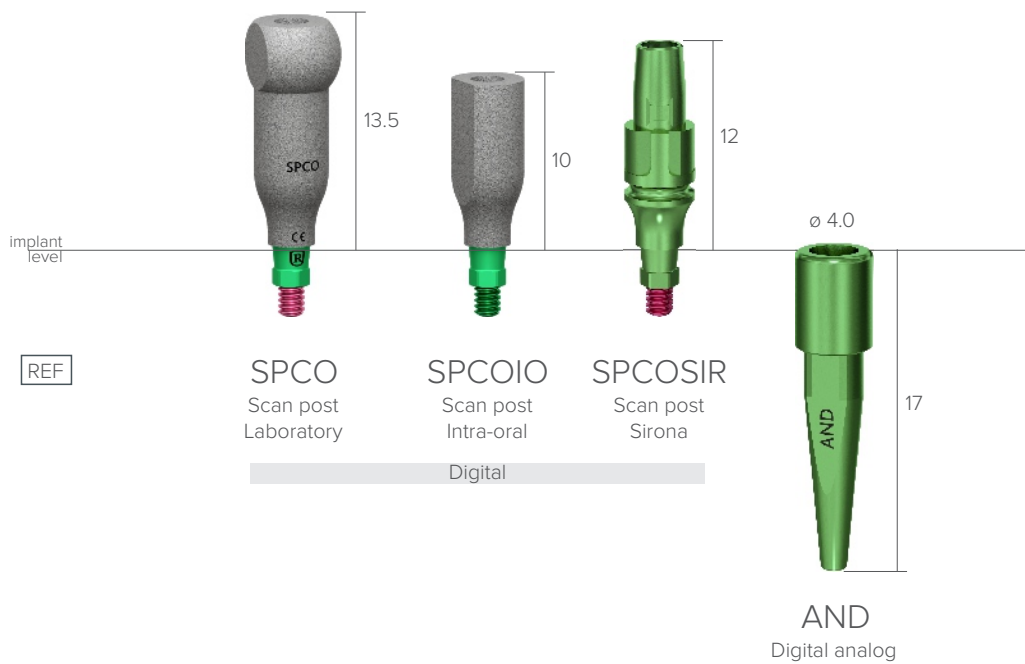
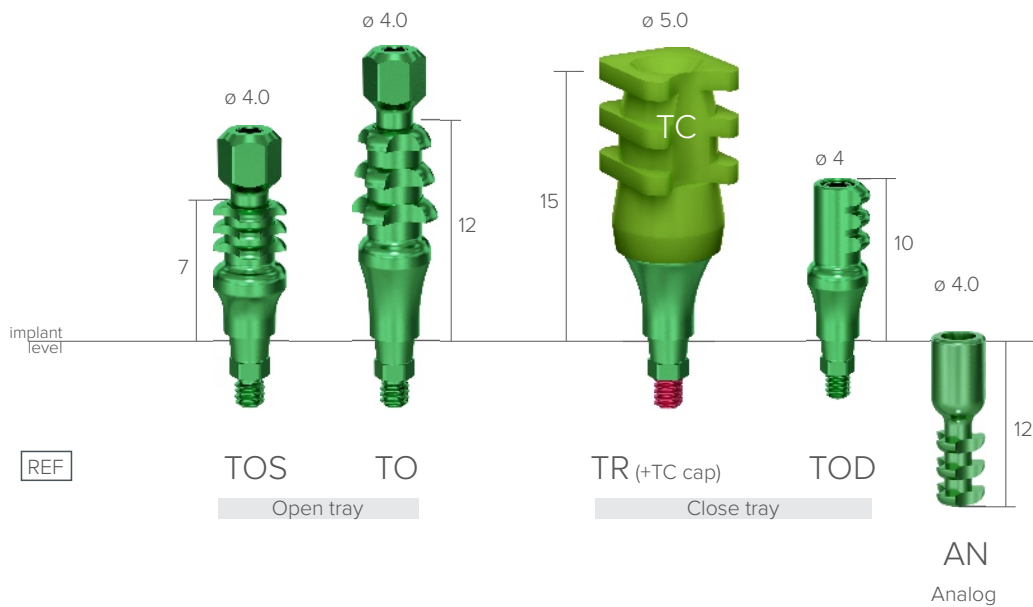

Abutments



Instructions

Straight anatomical abutments

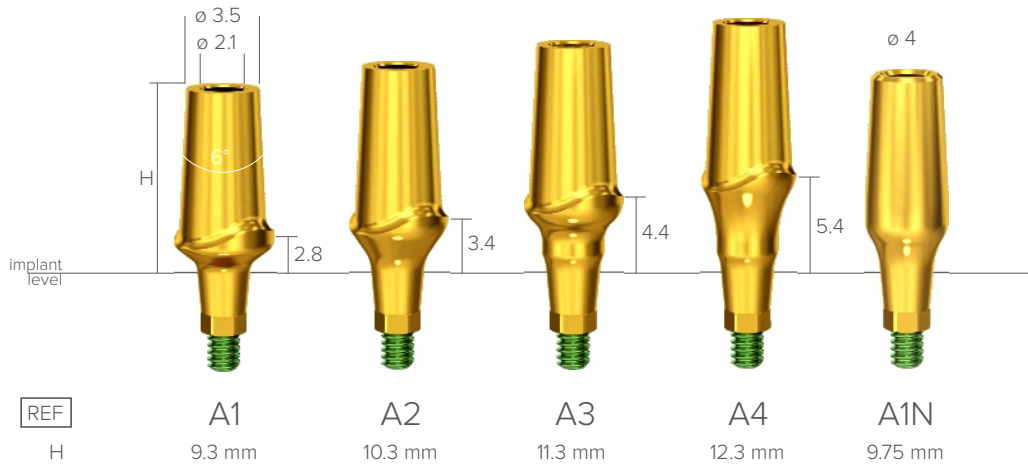

15° angled anatomical abutments

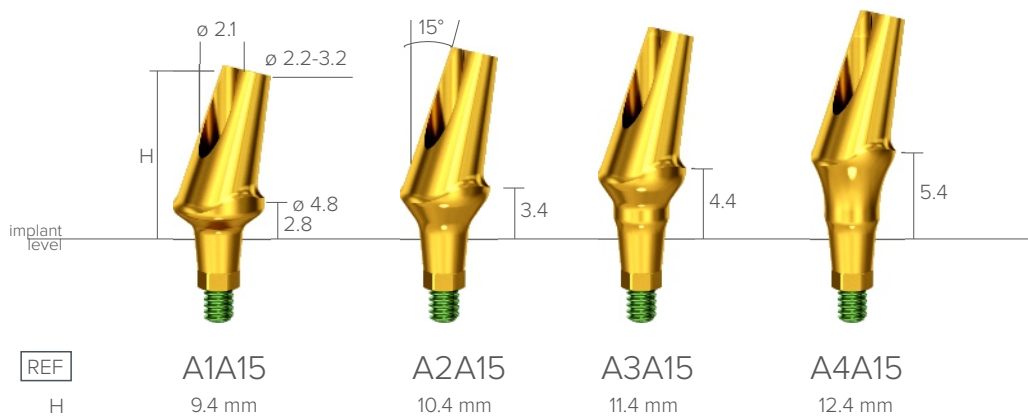

25° angled anatomical abutments

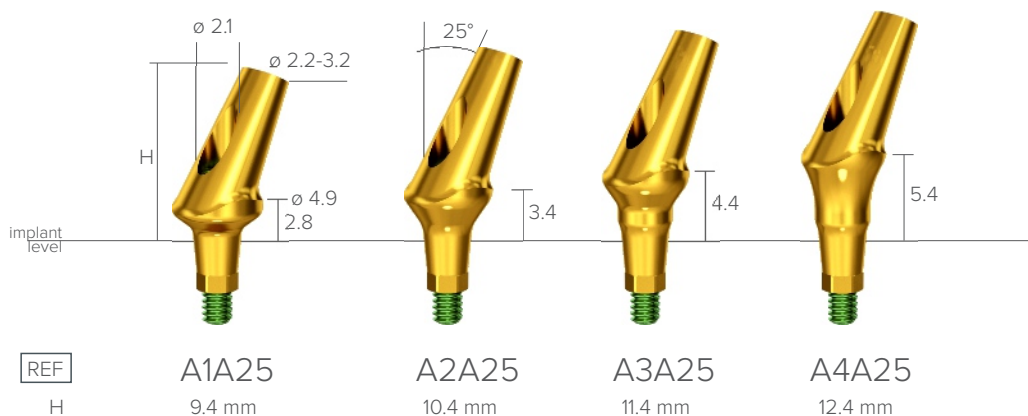

Transgingival abutments

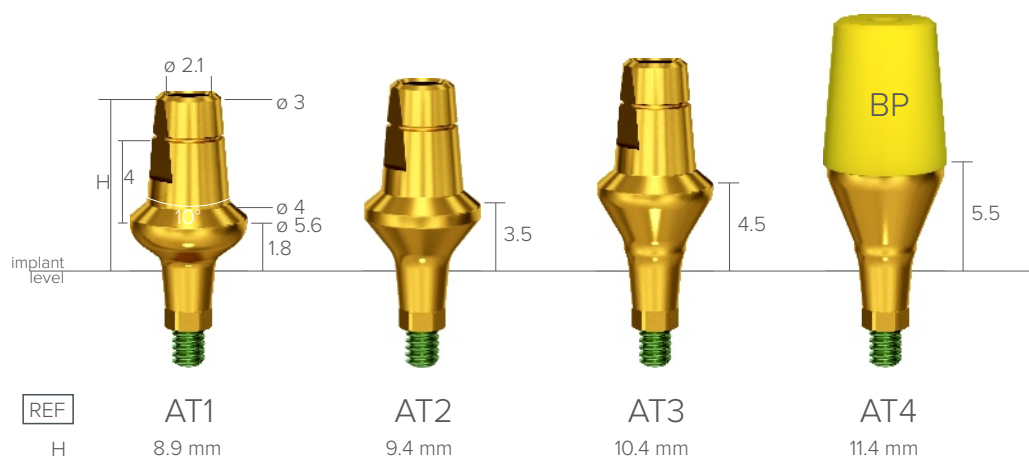

BP — free burn out part with each transgingival abutment

How it works

Place BP cap on AT abutment



Adjust height by cutting



Use wax for modelling future crown



Fix crown to AT abutment



One-piece abutments for telescopic fixation

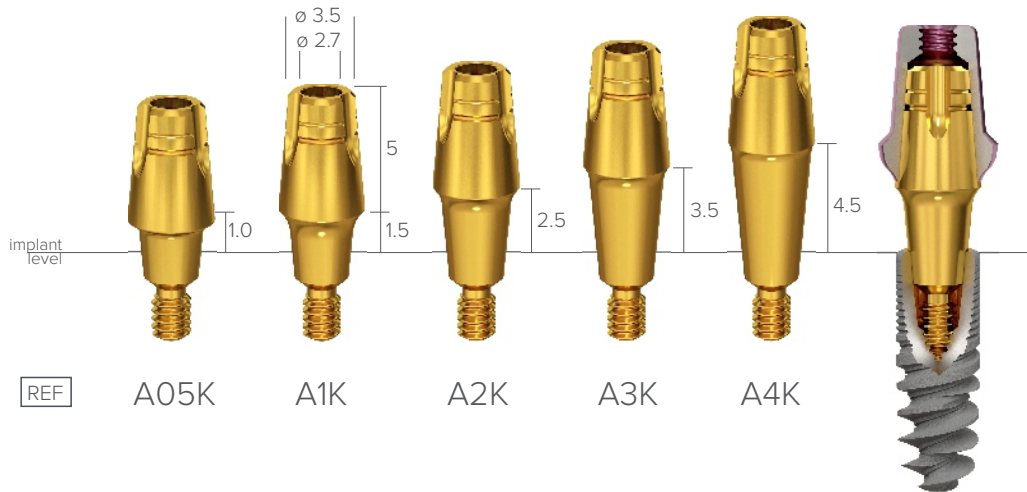

Narrow abutments for telescopic fixation

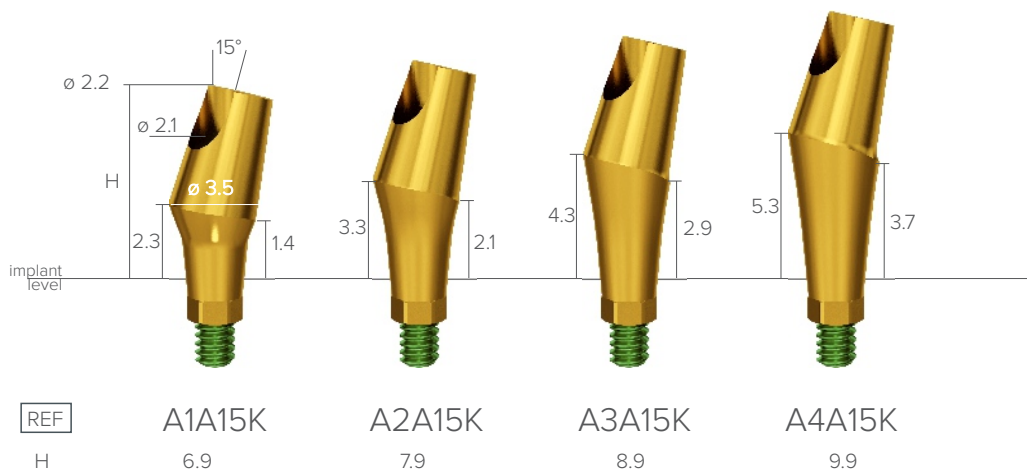

Titanium abutments for telescopic fixation



Attachments

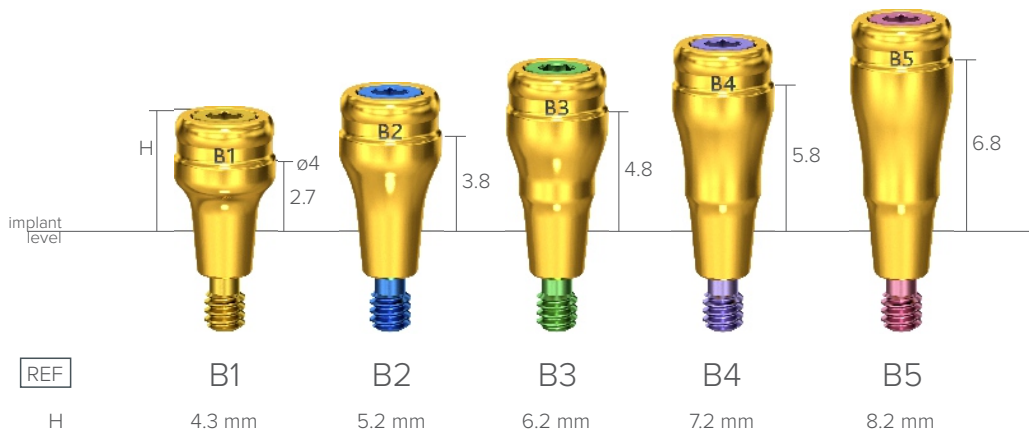

B1-B5 abutments have TiN coated surface for better wear resistance



Burn-out abutments

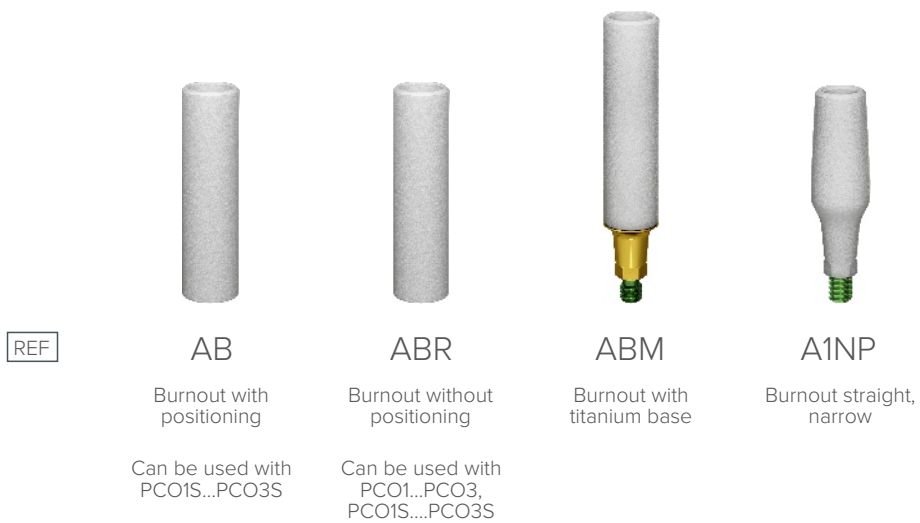

Titanium base

Regular

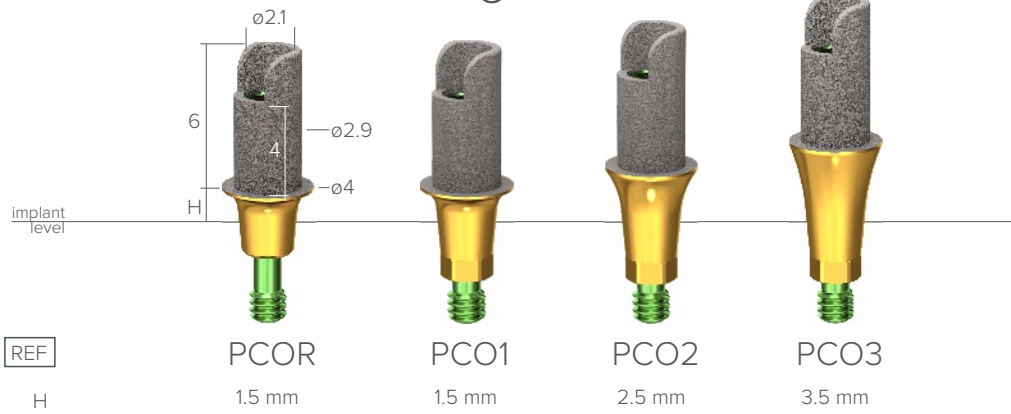

Short

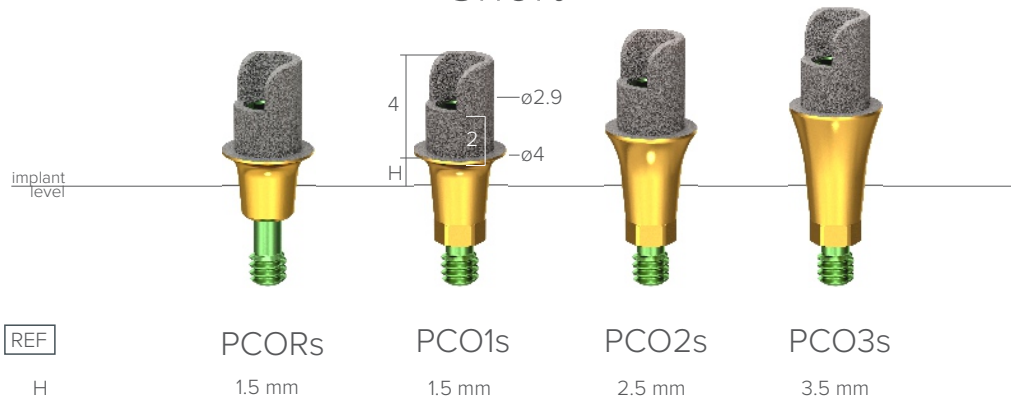

For Sirona



Pre-milled abutment



PMAB
Ø 11.5mm

Multi-unit abutments

Small multi-unit abutments



Regular multi-unit abutments

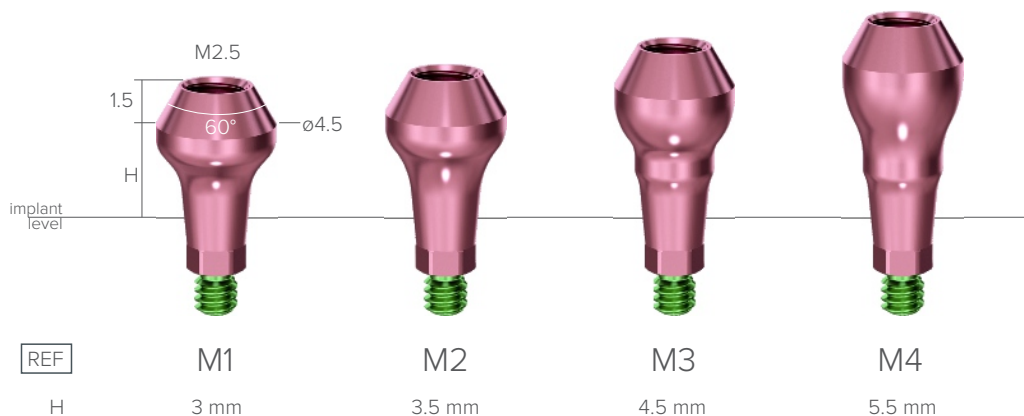

15° angled multi-unit abutments



30° angled multi-unit abutments



45° angled multi-unit abutments

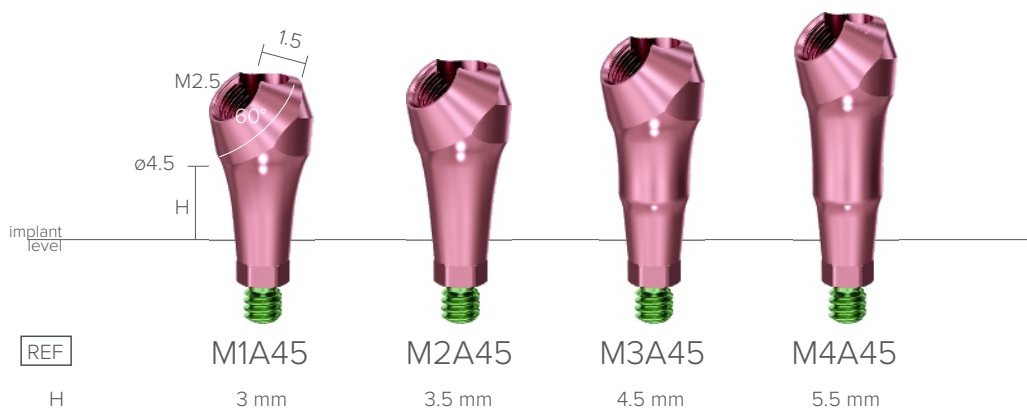

Superstructures for multi-unit abutments

Transfers & analogs

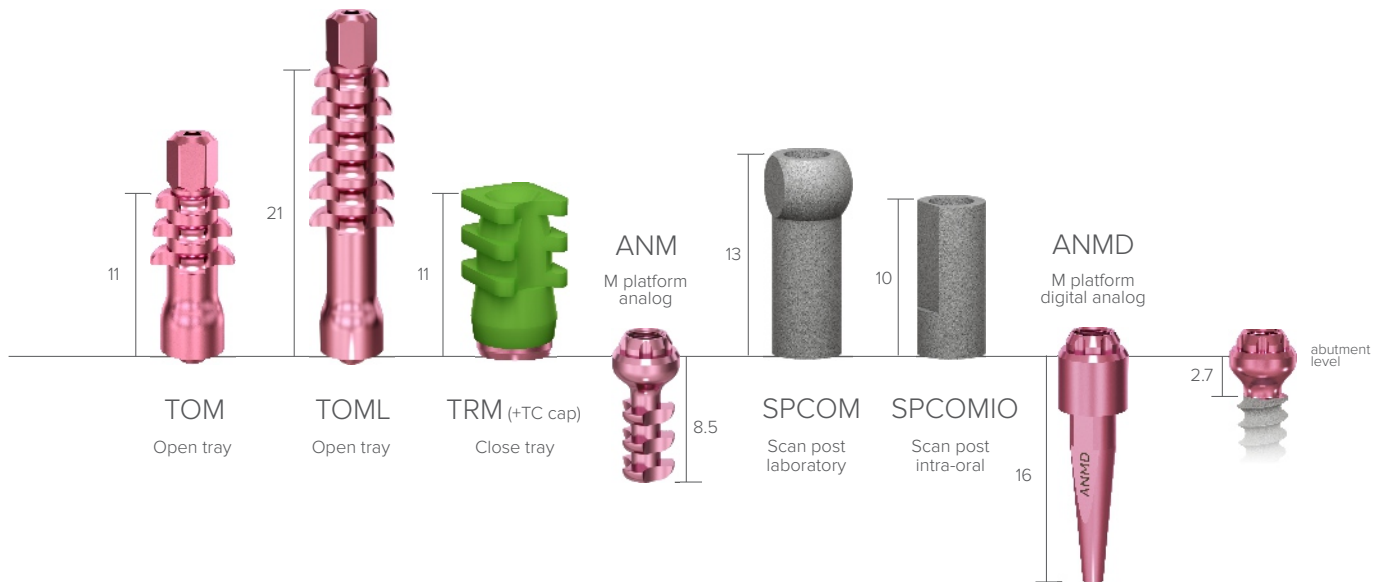

Abutments



Healing abutments



Superstructures for small multi-unit abutments

Transfers & analogs

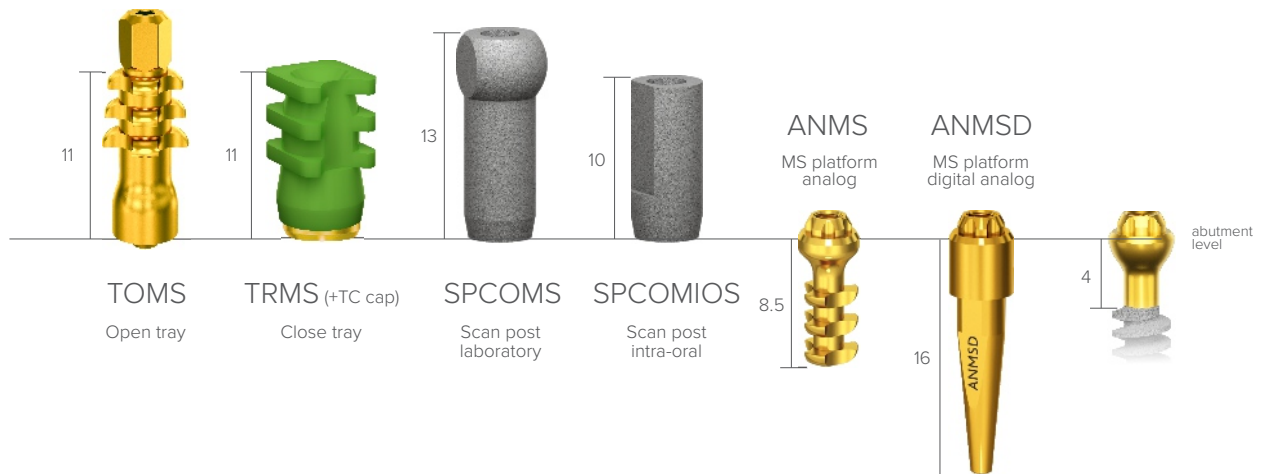

Abutments

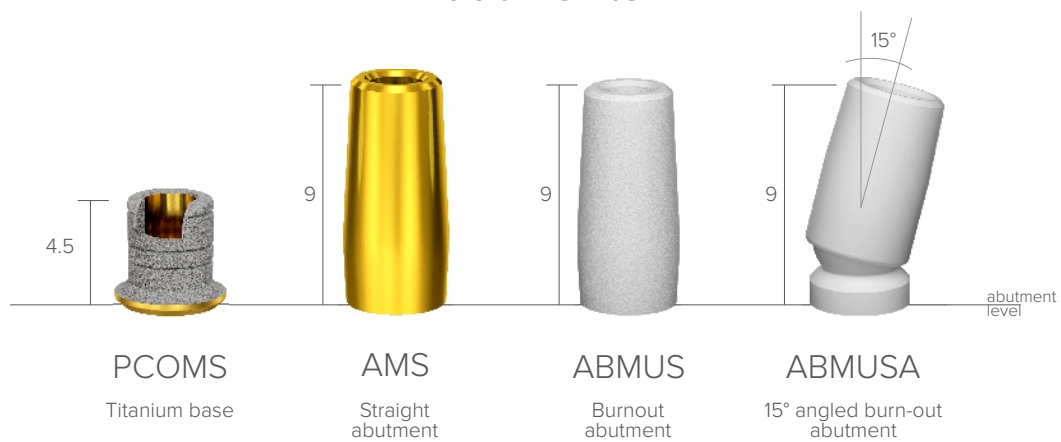

Healing abutments

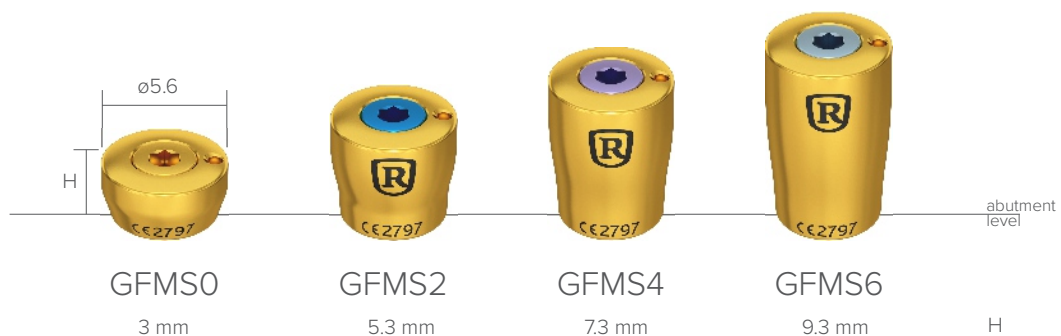

ROOTT C

Cement & telescopic retained

One-piece implant

Simple solution to bone atrophy

One-piece implant for more comfort and simplicity with a bendable neck for up to 15°. It ensures extreme time and cost-saving, which also comes with less complications and more patient acceptance.

Due to its thin design, excellent fit for narrow ridge and ensured safety due to the alveolar canal nerve bypass. Developed for single and multiple restorations.

Condensing thread

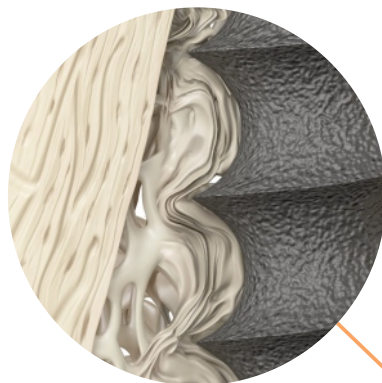

Avoiding inferior alveolar canal nerve

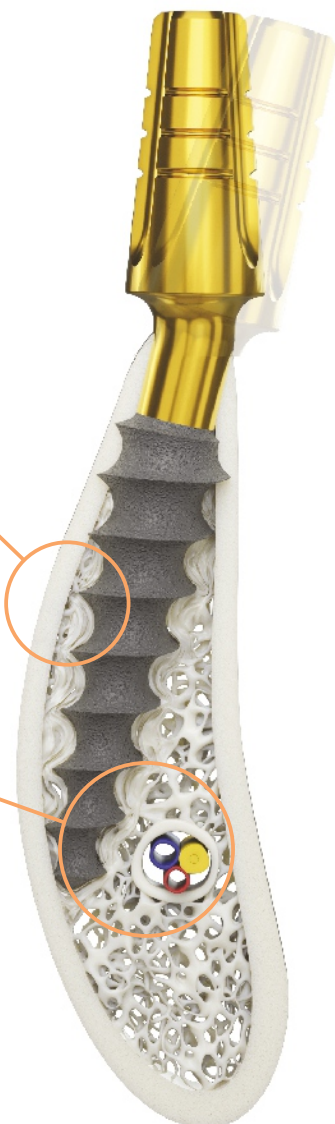
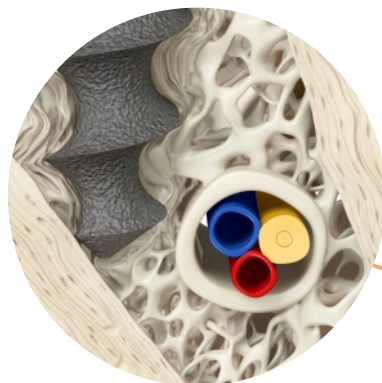

ROOTT C



Together with special condensing threads and embedded abutment with no microgaps, implant achieves excellent initial stability from the very beginning.





Significant time & cost saving



Immediate loadings



Excellent for narrow ridge



May avoid bone augmentation

ROOTT C

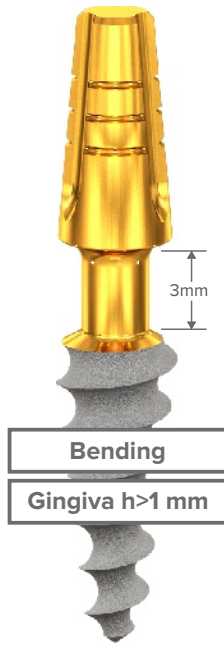

ROOTT CS

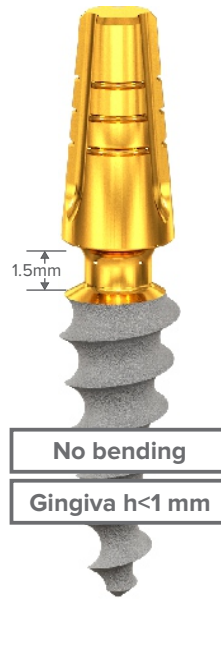

Clinical cases



By Dr. Alvaro Bastida

“FILO System is suitable in all clinical cases. Even esthetic area, narrow spaces, post-extraction and soft tissues management”

Prosthetic variety

Cement retain with trimmable external platform, burnouts or cement-free option with patented telescopic abutments.

Telescopic



Direct scan

5mm
4mm
3mm



Easy management

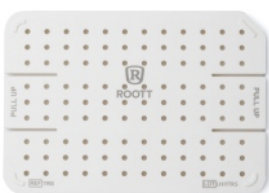

TRS

TRS-mini

More cases



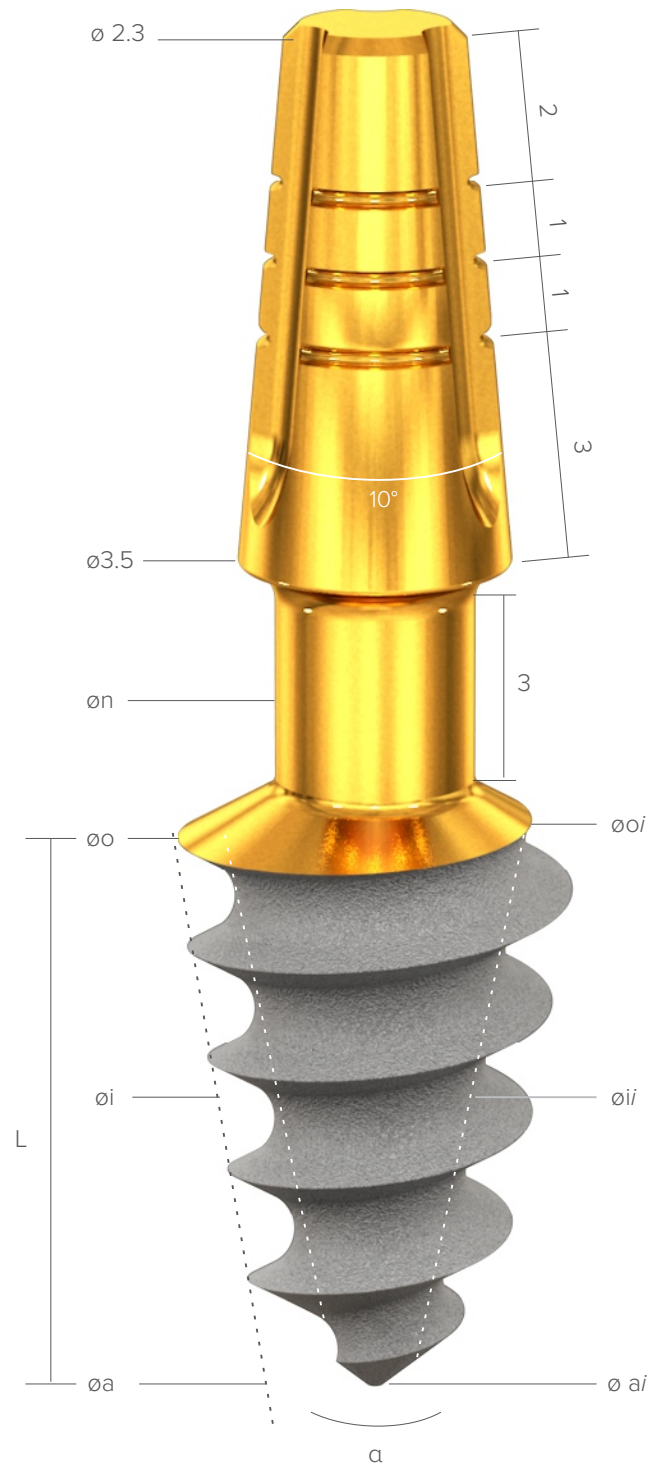

o - occlusal diameter (mm); i - intraosseous diameter (mm); a - apical diameter (mm); n - neck diameter;
 α - total internal angle ($^\circ$); s - intraosseous square area (mm²); i = internal.

L / o	ø 3.0	ø 3.5	ø 4.0	ø 4.5	ø 5.0	ø 5.5	ø 6.5	ø 7.5	ø 8.5
	oi 2.05 n 2.05	oi 2.46 n 2.05	oi 2.95 n 2.05	oi 3.05 n 2.35	oi 3.55 n 2.35	oi 4.04 n 2.55	oi 4.0 n 2.55	oi 4.0 n 2.55	oi 4.04 n 2.55
6 mm	 C3006 2.4 1.4 1.9 0.9 45 12	 C3506 2.6 1.6 1.9 0.9 49 17	 C4006 3.1 2.0 2.4 1.2 59 18	 C4506 3.5 2.1 2.9 1.4 73 18	 C5006 3.9 2.4 3.2 1.7 82 21	 C5506 4.1 2.7 3.2 1.8 88 27	 C6506 5.1 2.6 4.5 1.9 126 27	 C7506 6.1 2.3 5.8 2.6 144 27	 C8506 7.1 2.7 7.1 2.6 158 26
8 mm	 C3008 2.4 1.4 1.9 0.9 59 19	 C3508 2.6 1.6 1.9 0.9 65 13	 C4008 3.1 2.0 2.4 1.2 80 13	 C4508 3.6 2.2 2.9 1.4 100 13	 C5008 4.0 2.5 3.2 1.8 113 15	 C5508 4.2 2.7 3.2 1.8 121 19	 C6508 5.2 2.7 4.4 1.9 177 19	 C7508 6.2 2.6 5.6 2.1 208 19	 C8508 7.2 2.7 6.7 2.3 231 19
10 mm	 C3010 2.4 1.4 1.9 0.9 74 7	 C3510 2.6 1.6 1.9 0.9 82 10	 C4010 2.9 1.8 1.9 0.8 92 13	 C4510 3.4 1.9 2.4 1.0 117 13	 C5010 3.7 2.2 2.6 1.2 131 15	 C5510 3.8 2.4 2.5 1.0 139 19	 C6510 4.9 2.4 3.6 1.2 211 19	 C7510 5.8 2.7 4.5 2.4 251 19	 C8510 3.8 2.4 2.5 1.0 287 19
12 mm	 C3012 2.3 1.3 1.7 0.7 86 6	 C3512 2.6 1.6 1.8 0.8 97 9	 C4012 2.8 1.8 1.8 0.8 109 11	 C4512 3.3 1.9 2.4 0.9 139 11	 C5012 3.8 2.4 2.8 1.4 163 12	 C5512 3.9 2.5 2.5 1.1 167 16	 C6512 4.9 2.4 3.6 1.2 258 16	 C7512 5.9 2.4 4.8 1.3 309 16	 C8512 6.9 2.4 5.9 1.4 357 16
14 mm	 C3014 2.4 1.3 1.9 0.7 99 5	 C3514 2.6 1.5 1.8 0.7 111 8	 C4014 2.9 1.8 1.8 0.8 128 10	 C4514 3.3 1.9 2.3 0.9 162 10	 C5014 3.6 2.2 2.4 0.9 179 12	 C5514 3.8 2.3 2.3 0.8 191 14	 C6514 4.8 2.4 3.4 0.9 297 14	 C7514 5.8 2.4 4.5 1.1 359 14	 C8514 6.8 2.4 5.6 1.2 415 14
16 mm	 C3016 2.4 1.4 1.7 0.8 118 4	 C3516 2.6 1.6 1.8 0.8 129 6	 C4016 2.9 1.8 1.8 0.8 146 8	 C4516 3.3 1.9 2.3 0.8 184 9					
18 mm	 C3018 2.4 1.3 1.7 0.7 128 4	 C3518 2.6 1.7 1.8 0.8 146 6	 C4018 2.9 1.8 1.8 0.8 164 7	 C4518 3.3 1.9 2.2 0.8 206 8					
20 mm	 C3020 2.4 1.3 1.7 0.7 143 4	 C3520 2.6 1.6 1.8 0.7 161 5	 C4020 2.9 1.8 1.8 0.7 180 7	 C4520 3.3 1.9 2.2 0.8 229 7					

oi | oii
oa | oai
S | a

Ti6Al4V ELI

ROOTT CS

ROOTT C

- Bendable
- Gingiva H<1 mm
- Sinus area



ROOTT CS

- Bendable
- Gingiva H<1 mm
- Sinus area



L / o

ø 4.0

ø 4.5

6 mm



C4006s

3.1 | 2.0
2.4 | 1.2
59 | 18



C4506s

3.5 | 2.1
2.9 | 1.4
73 | 18

8 mm



C4008s

3.1 | 2.0
2.4 | 1.2
80 | 13



C4508s

3.6 | 2.2
2.9 | 1.4
100 | 13

10 mm



C4010s

2.9 | 1.8
1.9 | 0.8
92 | 13



C4510s

3.4 | 1.9
2.4 | 1.0
117 | 13

øi | øii
øa | øai
S | α

Ti6Al4V ELI

ROOTT **B** **BS**

Cement & telescopic retained

One-piece implant



Avoids bone grafting



Time & cost saving



Immediate loadings



Extraction sockets
Healed bone

Especially effective in atrophic bone with bi-cortical engagement

ROOTT B and ROOTT BS one-piece implants are designed for deficient bone in height and width. It provides efficiency in time and costs, with a bending option and a very sharp thread to enter corticalized and medullary bone. Designed to bypass the mandibular nerve, and for engagement of the cortical bone at the fusion of the pterygoid with the maxilla. Can be used with ROOTT C implants



Bending

Abutment direction can be adjusted up to 15° relative to the implant axis, when implant neck is equal or longer than 3mm.



Surface

ROOTT B implant surface is polished for protection from bacteria accumulation

B **BS**



ROOTT BS is RBM blasted and anodized. RBM surface provides:

- high BIC*
- great osseointegration
- high success rate

*Bone-to-implant connection

Sizes

Ø: 3.5–10.5mm
L: 6–26mm

Ø: 3.5–4.5mm
L: 6–26mm

Prosthetic variety

Cement retain with trimmable external platform, burnouts or cement-free option with patented telescopic abutments.

Telescopic



Direct scan

5mm
4mm
3mm



Easy management

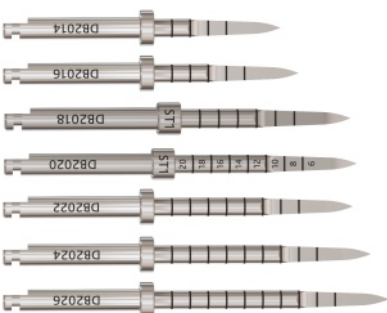

Clinical cases



By Dr. Ariel Pedernera

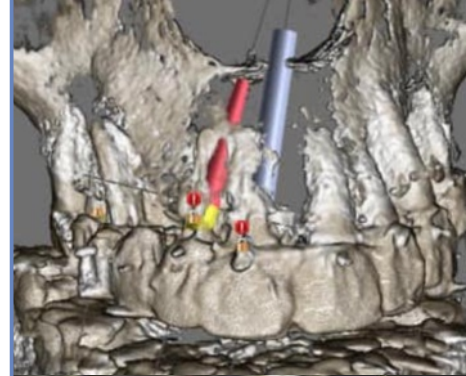
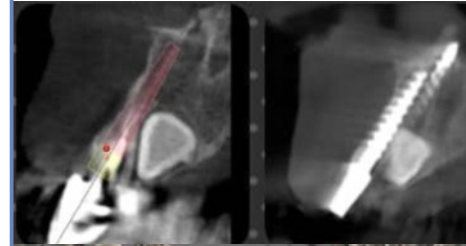

More cases



ROOTT B

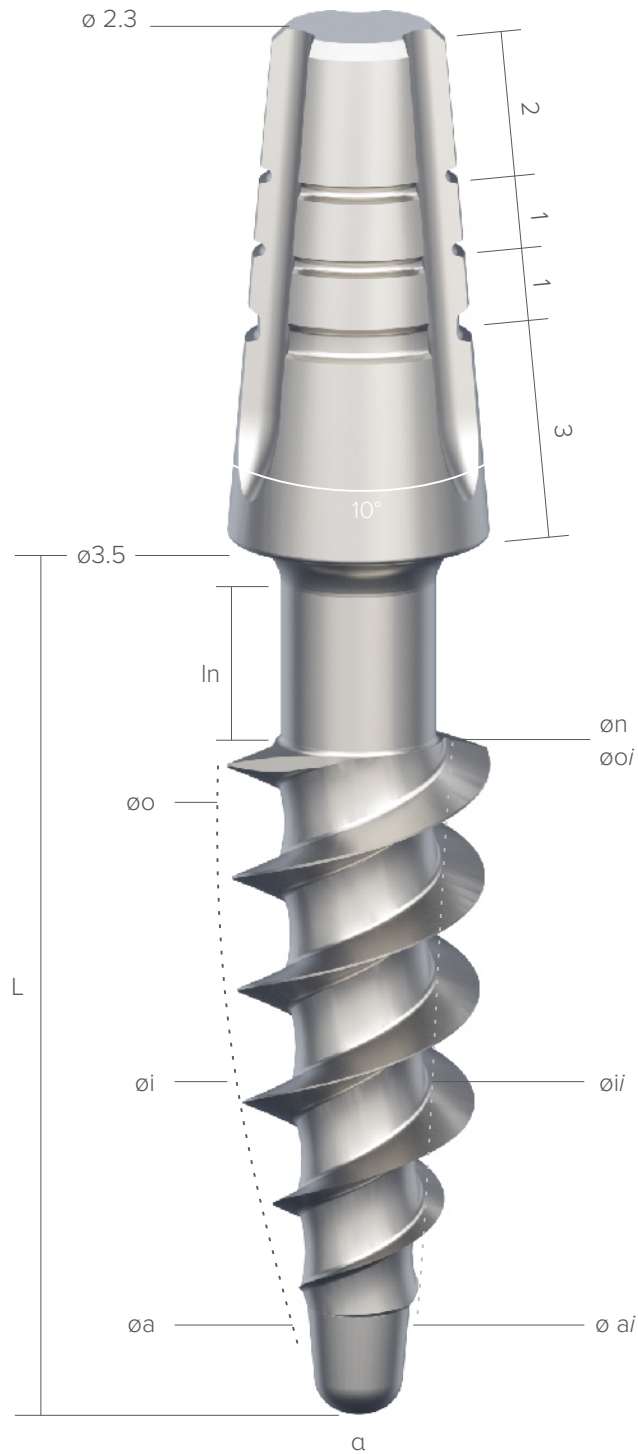

o - occlusal diameter (mm); i - intraosseous diameter (mm); a - apical diameter (mm); n - neck diameter;
 α - total internal angle (°); s - intraosseous square area (mm²); i = internal.

ø / L	6 mm	8 mm	10 mm	12 mm	14 mm	16 mm	18 mm	20 mm	22 mm	24 mm	26 mm
	In 1.5	In 3	In 3	In 3	In 5	In 7	In 7	In 7	In 7	In 7	In 7
ø 3.5	B3506	B3508	B3510	B3512	B3514	B3516	B3518	B3520	B3522	B3524	B3526
øi 3.1 øii 1.6 øai 1.4 n 2.05	s 73 a 18	s 45 a 13	s 60 a 6	s 80 a 5	s 80 a 5	s 80 a 5	s 103 a 4	s 126 a 3	s 146 a 3	s 165 a 2	s 188 a 2

ø 4.5	B4508	B4510	B4512	B4514	B4516	B4518	B4520	B4522	B4524	B4526
øi 4.2 øii 2.0 øai 1.7 n 2.35	s 68 a 13	s 90 a 6	s 122 a 5	s 122 a 5	s 122 a 5	s 158 a 4	s 195 a 3	s 225 a 3	s 256 a 2	s 292 a 2

ø 5.5	B5508	B5510	B5512	B5514	B5516	B5518	B5520
øi 4.3 øii 2.1 øai 1.4 n 2.35	s 101 a 10 In 1.5	s 98 a 9	s 129 a 7	s 142 a 6	s 142 a 6	s 181 a 5	s 226 a 4

ø / L	8 mm	10 mm	12 mm	14 mm	16 mm	18 mm
	In 1.5	In 3	In 3	In 5	In 7	In 7

ø 6.5	B6508	B6510	B6512	B6514	B6516
-------	-------	-------	-------	-------	-------

øi 5.5
øii 1.7
øai 1.4
n 2.35

s 120
a 10



s 113
a 9



s 132
a 7



s 150
a 6



s 145
a 6



ø 8.5	B8508	B8510	B8512	B8514	B8516	B8518
-------	-------	-------	-------	-------	-------	-------

øi 7.3
øii 1.7
øai 1.7
n 2.35

s 143
a 10



s 117
a 9



s 116
a 9
In 5



s 118
a 9
In 7



s 264
a 6



s 351
a 6



ø 10.5

øi 7.1
øii 1.9
øai 1.7
n 2.35

B1110

s 145
a 5



B1112

s 145
a 5
In 5



B1114

s 145
a 5
In 7



ROOTT BS

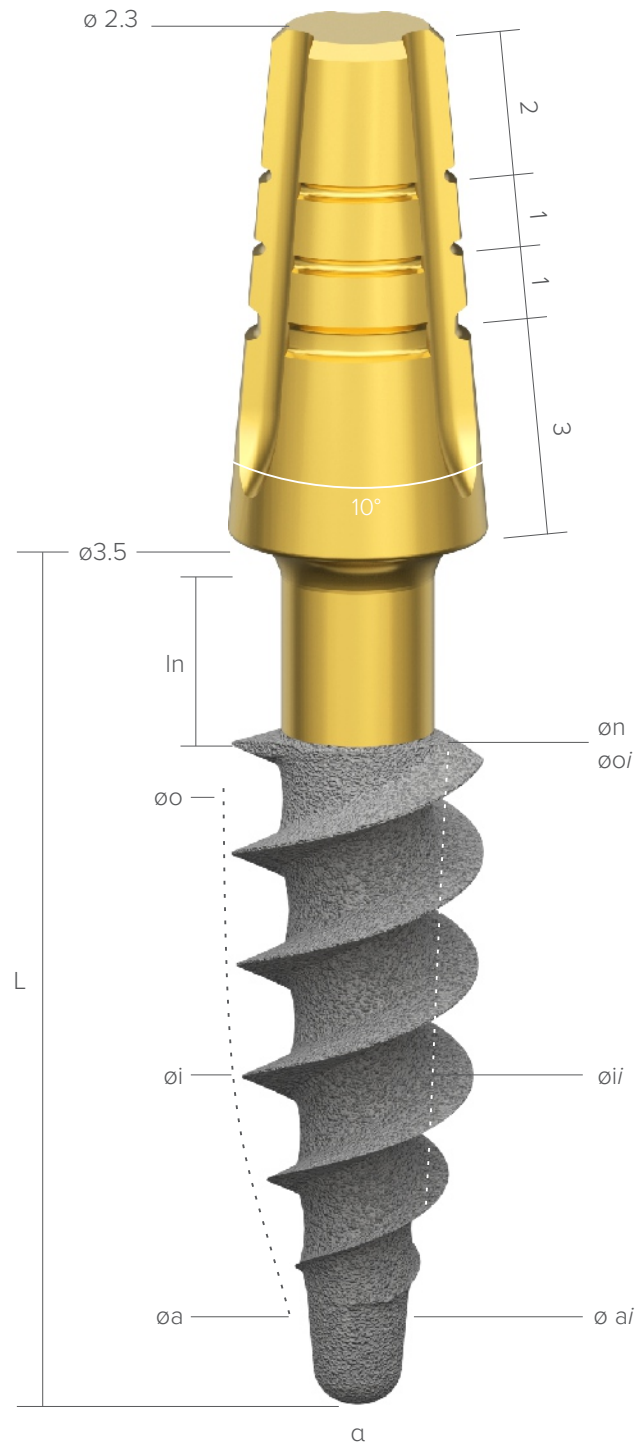

o - occlusal diameter (mm); i - intraosseous diameter (mm); a - apical diameter (mm); n - neck diameter;
 α - total internal angle ($^{\circ}$); s - intraosseous square area (mm^2); i = internal.

o / L	6 mm	8 mm	10 mm	12 mm	14 mm	16 mm	18 mm	20 mm	22 mm	24 mm	26 mm
	In 1.5	In 3	In 3	In 3	In 5	In 7	In 7	In 7	In 7	In 7	In 7
∅ 3.5	B3506ss	B3508ss	B3510ss	B3512ss	B3514ss	B3516ss	B3518ss	B3520ss	B3522ss	B3524ss	B3526ss
∅i 3.1 ∅ii 1.6 ∅ai 1.4 n 2.05	s 73 a 18	s 45 a 13	s 60 a 6	s 80 a 5	s 80 a 5	s 80 a 5	s 103 a 4	s 126 a 3	s 146 a 3	s 165 a 2	s 188 a 2
											
∅ 4.5	B4506ss	B4508ss	B4510ss	B4512ss	B4514ss	B4516ss	B4518ss	B4520ss			
∅i 4.2 ∅ii 2.0 ∅ai 1.7 n 2.35	s 116 a 13	s 68 a 9	s 90 a 6	s 122 a 5	s 122 a 5	s 122 a 5	s 158 a 4	s 195 a 3			
											

External platform

Transfers

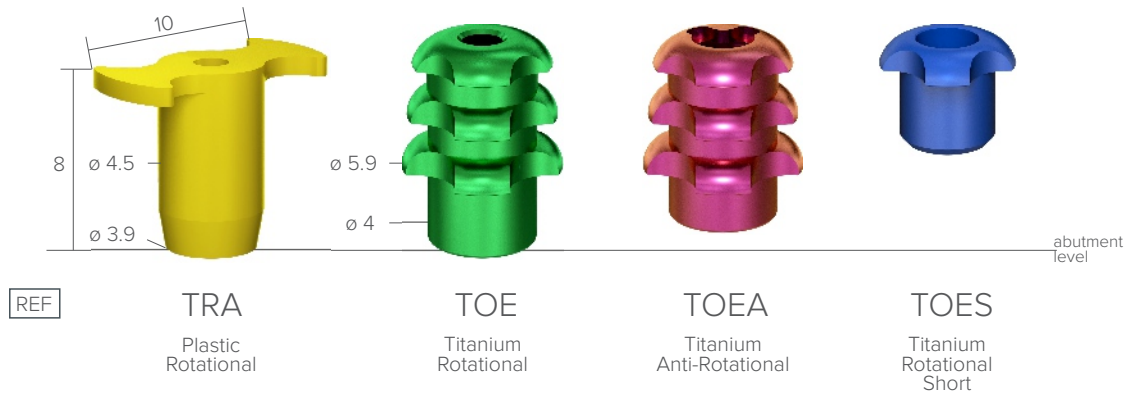

Analogs



Healing abutments



Telescopic abutments, titanium



Burn-out abutments

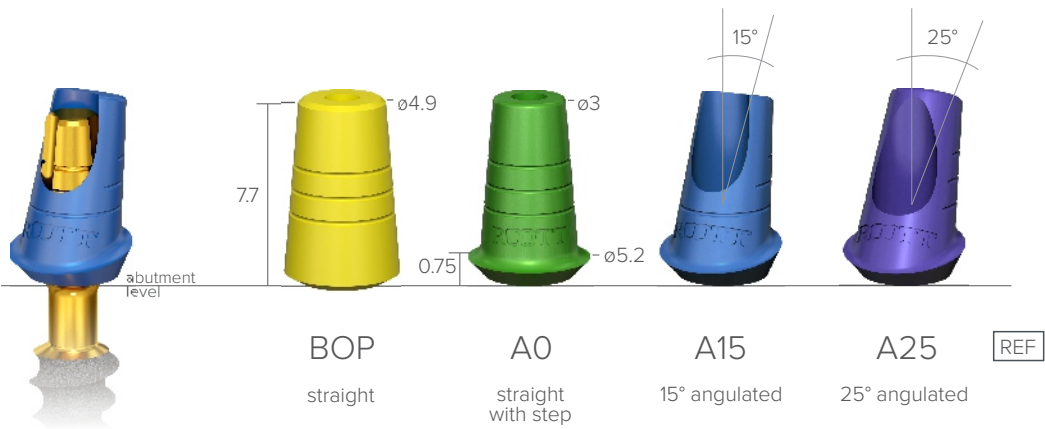



One-piece implant

Screw retained



Complete control & easy maintenance

Screw-retained restorations represent a secure and easy way to repair, maintain prosthesis, and treat peri-implant tissue inflammations more efficiently without damaging the suprastructure. ROOTT P, ROOTT M, ROOTT S are designed to use in combination for a cement-free full jaw restoration with 60 degrees between implant axes. Also, can be used with all ROOTT implants.

ROOTT **P**



Long enough to tolerate the distance between pterygoid area and maxilla

Ø 2.5 prosthetic screw

Extreme condensing threads for excellent stability

L 16–26mm
Ø 3.5–4.5mm

ROOTT **M**



Designed for posterior jaw area

Ø 2.5 prosthetic screw

Condensing threads

L 6–20mm
Ø 3.0–8.0mm

ROOTT **S**



Excellent aesthetics in front jaw bone

Ø 1.8 prosthetic screw

Condensing threads

L 8–16mm
Ø 3–3.5mm

- ✓ Less invasive
- 🕒 Immediate loadings
- 🔪 Avoids sinus lift & bone grafting
- 👓 Multiple restoration



AM AMS

Direct scan

Ultra resistant Ø2.5 mm screw



- 🔩 Easy handling
Less likely losing a screw
- 🦷 Excellent fixation
Withstands occlusal forces

Easy management

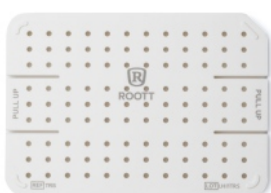

TRS



TRS-mini

Clinical cases



By Med. Dent. Henri Diedrich

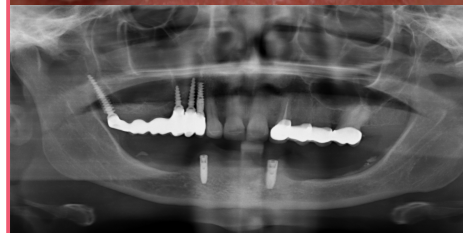

By Dr. Daniel Saad

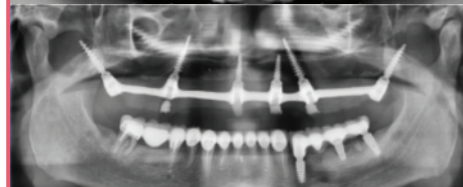







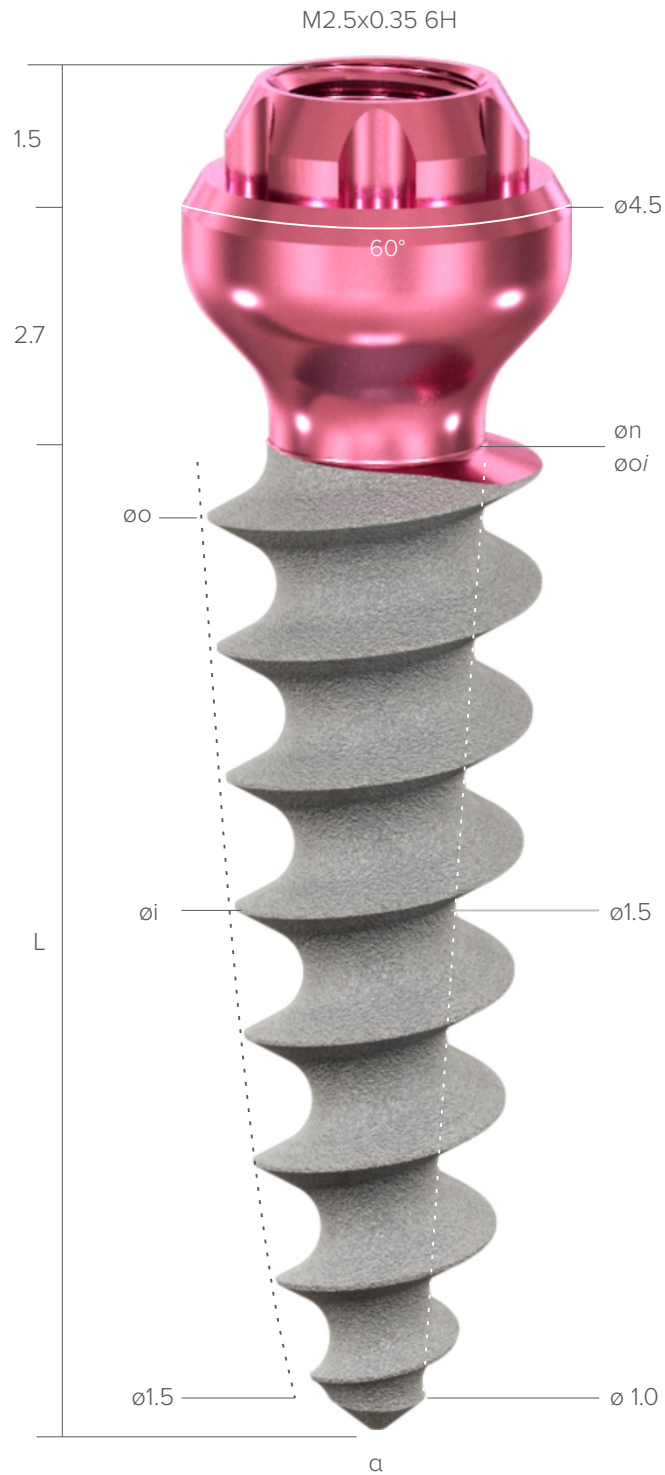





























More cases



ROOTT M



o - occlusal diameter (mm); i - intraosseous diameter (mm); a - apical diameter (mm); n - neck diameter;
α - total internal angle (°); s - intraosseous square area (mm²); i = internal.

o / L	6 mm	8 mm	10 mm	12 mm	14 mm	16 mm	18 mm	20 mm
ø 3.0		C3008m	C3010m	C3012m	C3014m	C3016m	C3018m	C3020m
øi 2.5 n 2.05		s 63 a 8 	s 79 a 6 	s 95 a 5 	s 112 a 4 	s 128 a 4 	s 145 a 3 	s 161 a 3 
ø 3.5	C3506m	C3508m	C3510m	C3512m	C3514m	C3516m	C3518m	C3520m
øi 2.8 n 2.55	s 54 a 15 	s 72 a 11 	s 91 a 9 	s 109 a 7 	s 127 a 6 	s 146 a 6 	s 164 a 5 	s 182 a 5 
ø 4.0	C4006m	C4008m	C4010m	C4012m	C4014m	C4016m		
øi 3.3 n 2.55	s 63 a 15 	s 86 a 11 	s 108 a 9 	s 130 a 7 	s 152 a 6 	s 174 a 6 		
ø 5.0	C5006m	C5008m	C5010m	C5012m	C5014m			
øi 4.3 n 2.55	s 82 a 15 	s 111 a 11 	s 141 a 9 	s 170 a 7 	s 200 a 6 			
ø 6.0	C6006m	C6008m	C6010m	C6012m	C6014m			
øi 5.3 n 2.55	s 124 a 15 	s 175 a 11 	s 219 a 9 	s 266 a 7 	s 313 a 6 			
ø 8.0	C8006m	C8008m	C8010m	C8012m	C8014m			
øi 7.3 n 2.55	s 321 a 15 	s 462 a 11 	s 596 a 9 	s 731 a 7 	s 865 a 6 			

ROOTT **P**

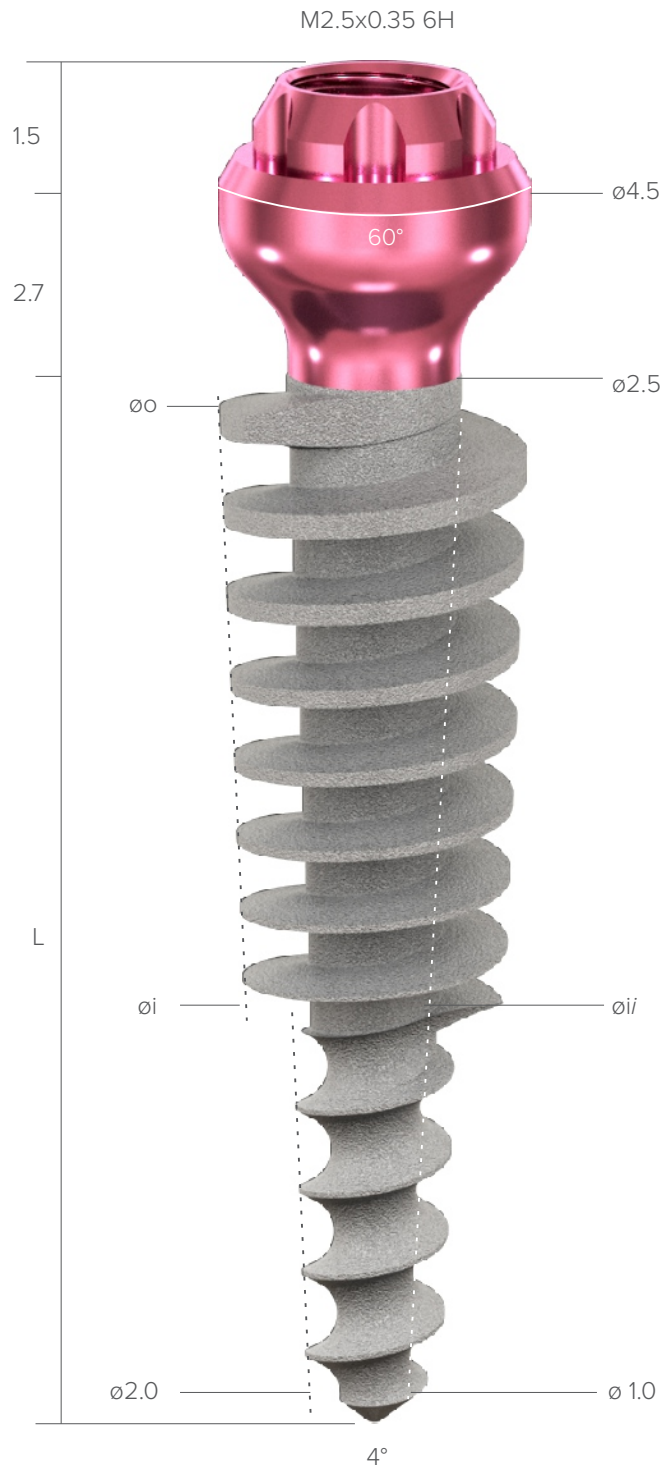

o - occlusal diameter (mm); i - intraosseous diameter (mm); a - apical diameter (mm); n - neck diameter;
 α - total internal angle (°); s - intraosseous square area (mm²); i = internal.

o / L 16 mm 18 mm 20 mm 22 mm 24 mm 26 mm

ø 3.5 C3516mp C3518mp C3520mp C3522mp C3524mp C3526mp

i 2.8
i/ 1.7
s 175

i 2.7
i/ 1.7
s 198

i 2.5
i/ 1.5
s 220

i 2.6
i/ 1.5
s 248

i 2.6
i/ 1.5
s 274

i 2.6
i/ 1.5
s 297



ø 4.5 C4516mp C4518mp C4520mp C4522mp C4524mp C4526mp

i 3.9
i/ 1.8
s 251

i 3.7
i/ 1.7
s 290

i 3.6
i/ 1.5
s 329

i 3.4
i/ 1.4
s 369

i 3.3
i/ 1.2
s 402

i 3.3
i/ 1.3
s 443



Transfers & implant analogs

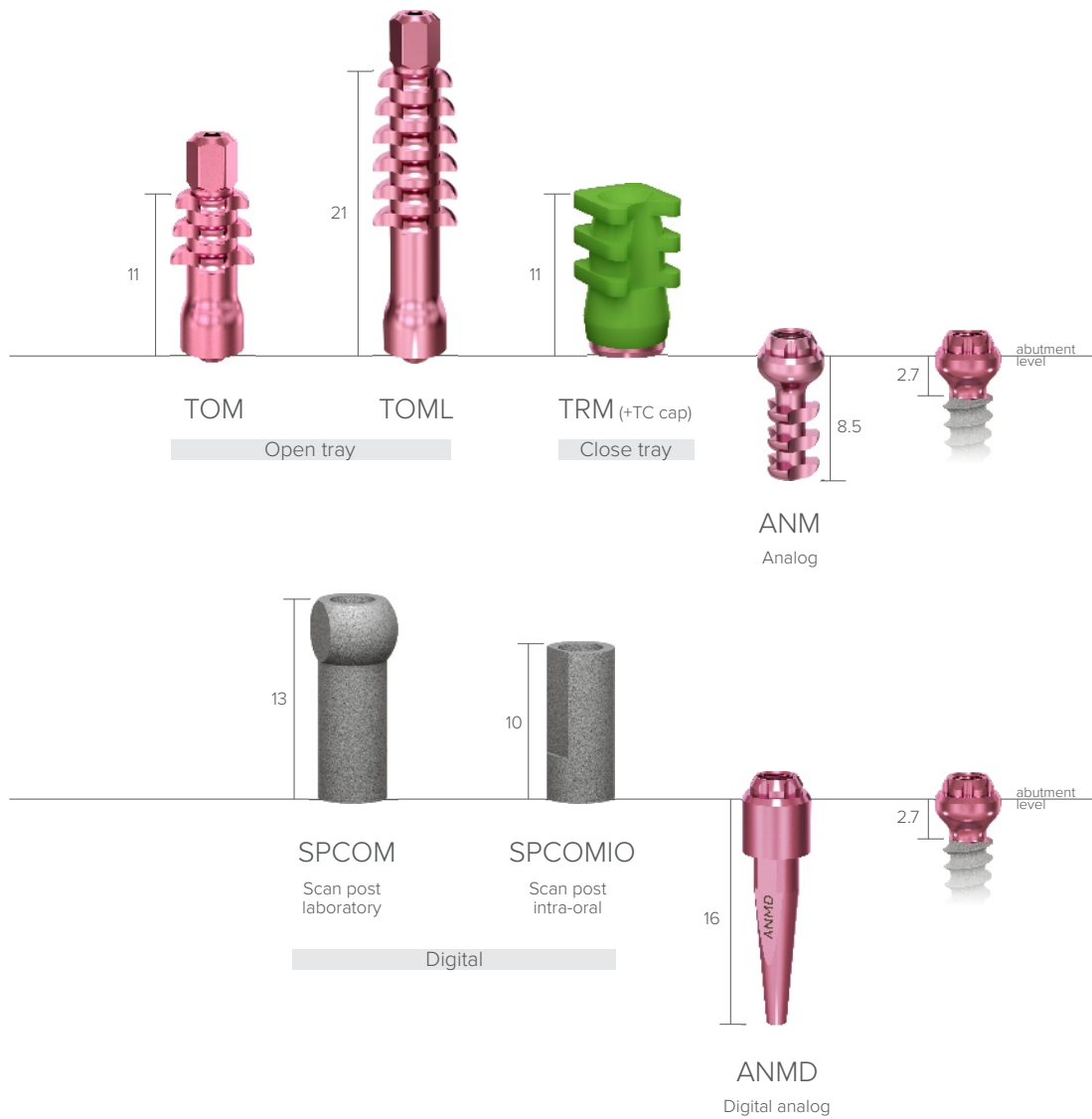

Abutments



Healing abutments

Regular



Narrow



Narrow healing abutments GFNM0-GFNM6 have TiN coated surface for better wear resistance. Color - yellow.

ROOTT **S**

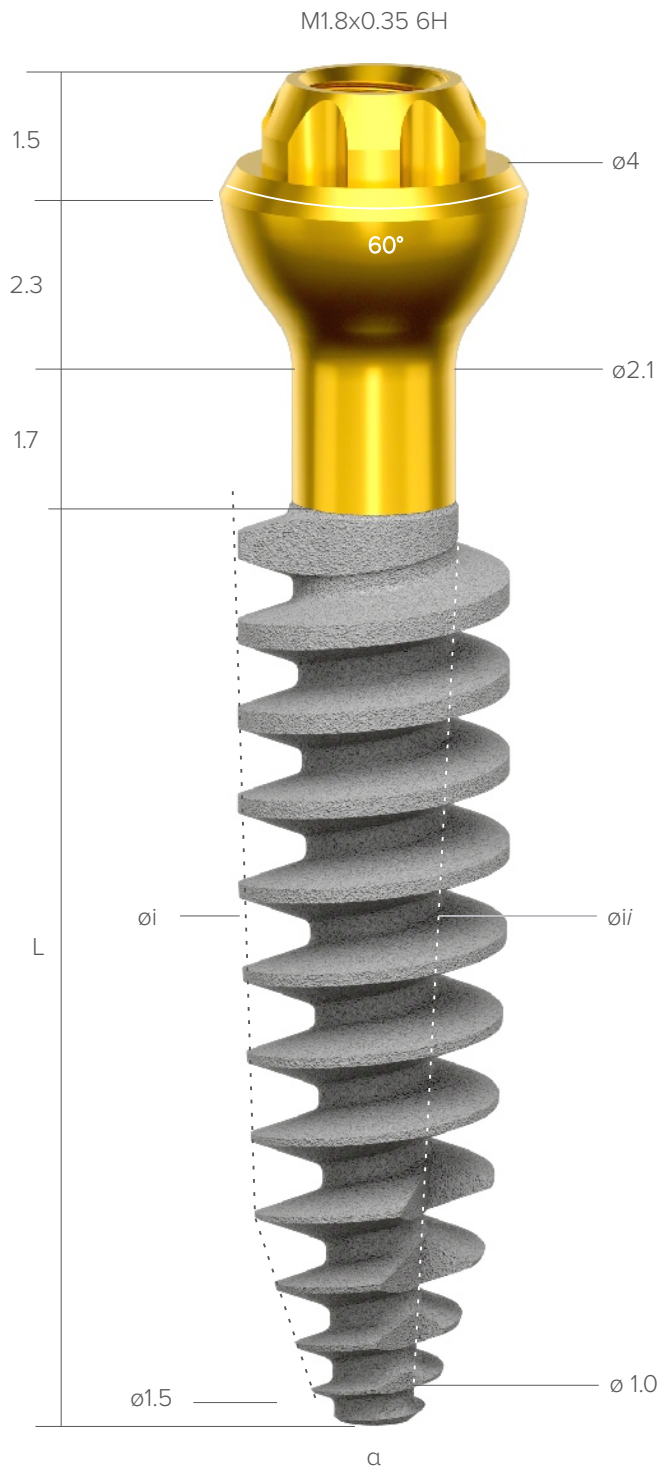

o - occlusal diameter (mm); i - intraosseous diameter (mm); a - apical diameter (mm); n - neck diameter;
 α - total internal angle (°); s - intraosseous square area (mm²); i = internal.

o / L 6 mm 8 mm 10 mm 12 mm 14 mm 16 mm

ø 3.0

øi 3.0
øi/ 1.5

C3008ms

s 93
a 8



C3010ms

s 119
a 6



C3012ms

s 142
a 5



C3014ms

s 165
a 4



C3016ms

s 187
a 4



ø 3.5

øi 3.5
øi/ 1.6

C3506ms

s 85
a 11



C3508ms

s 109
a 8



C3510ms

s 140
a 6



C3512ms

s 170
a 5



C3514ms

s 199
a 4



C3516ms

s 227
a 4



Transfers & implant analogs

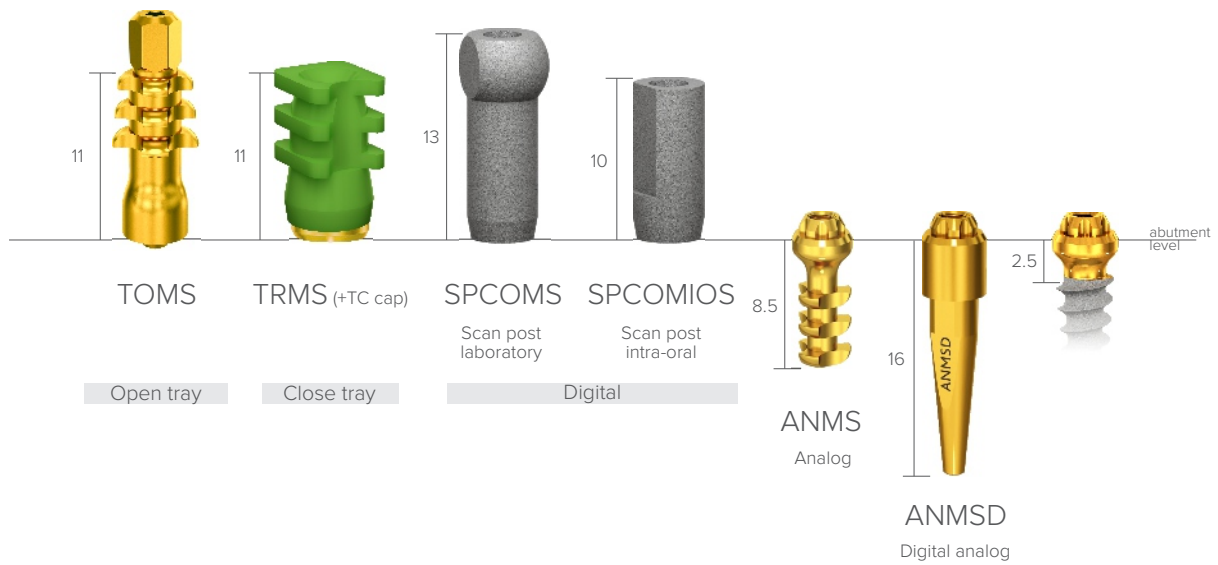

Abutments

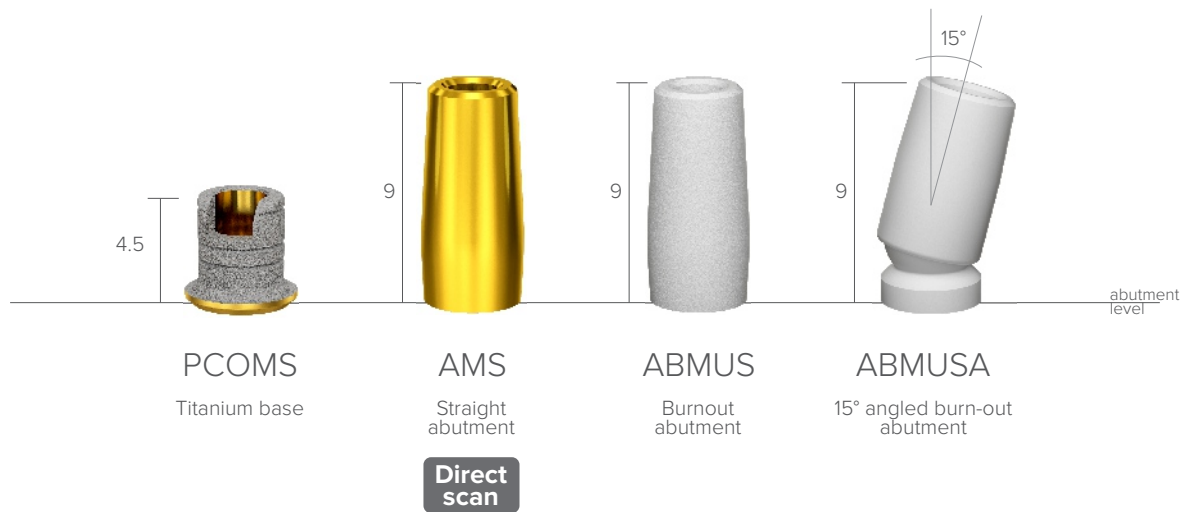

Healing abutments

Regular

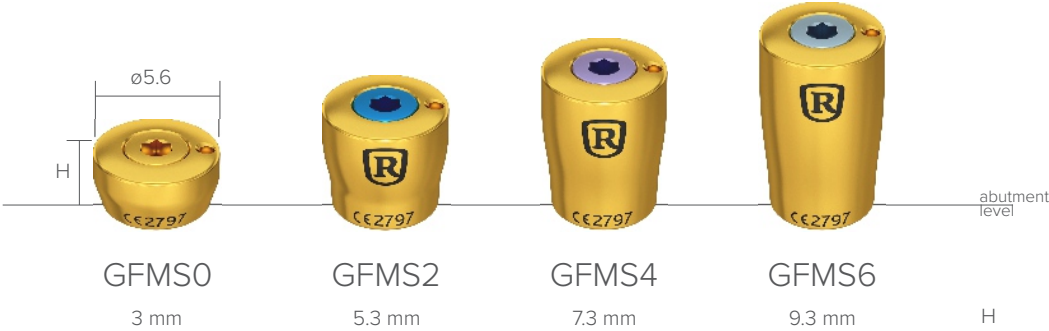

Narrow



Narrow healing abutments GFNMS0-GFNMS6 have TiN coated surface for better wear resistance.

ROOTT K

Cement & telescopic retained

One-piece implant

Excellent stability in lateral alveolar walls & soft bone

The implant body is developed regarding the natural formation of the bone and is made from high-strength Commercially Pure Titanium (CP Ti Grade 4), which provides great integration.

CP Ti Grade 4 characterizes by good corrosion resistance, high toughness, and endurance, which is excellent for medical tools and implants. This design is built with patients' comfort in mind, with ideal usage for specialists.

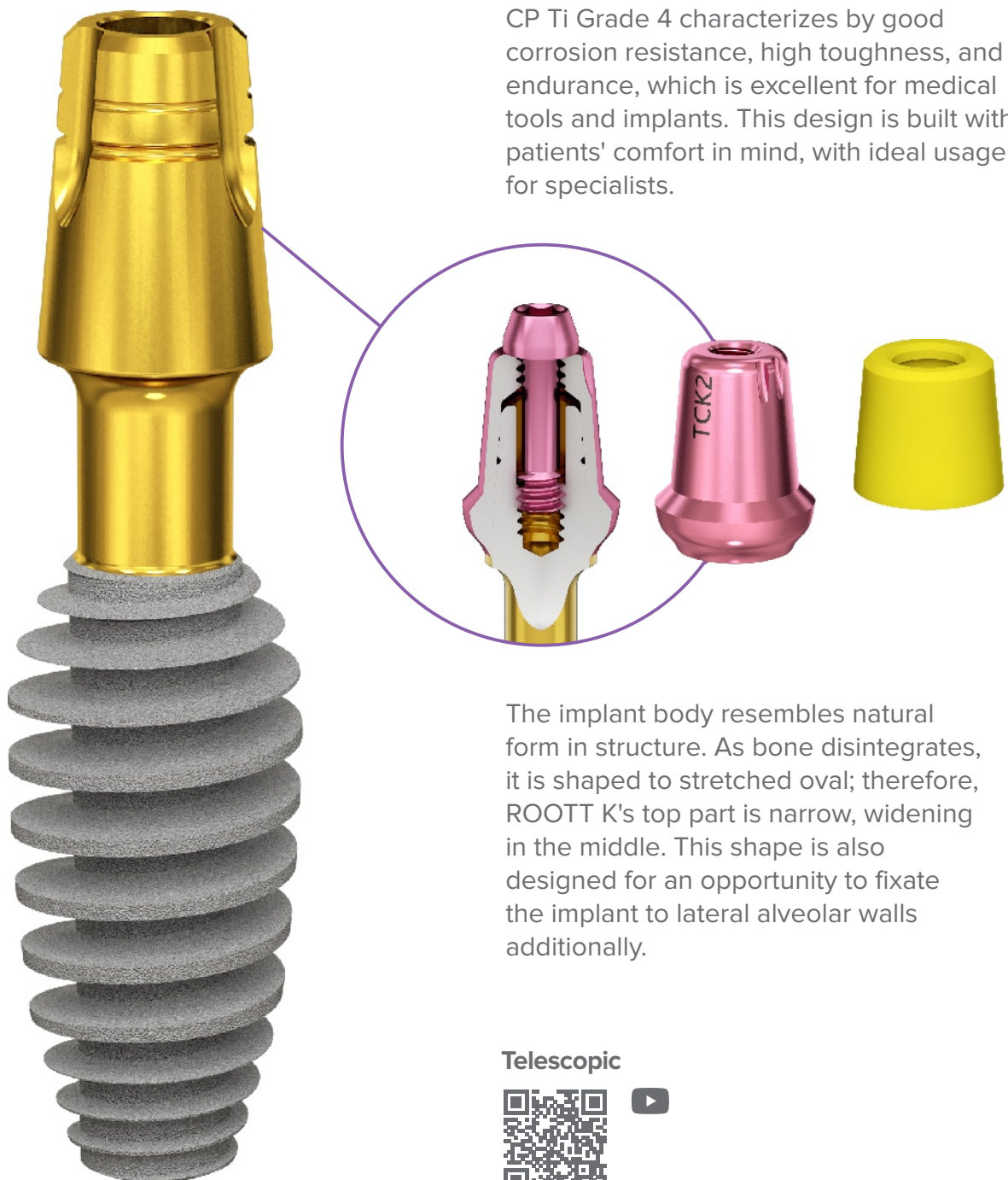

The implant body resembles natural form in structure. As bone disintegrates, it is shaped to stretched oval; therefore, ROOTT K's top part is narrow, widening in the middle. This shape is also designed for an opportunity to fixate the implant to lateral alveolar walls additionally.

Telescopic



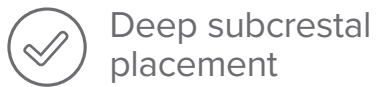

Deep subcrestal placement



Telescopic retained



No screws under the gum



Cement retained

Surface area

R3510
137.3mm²

C3510
81.8mm²

C3510k
145.7mm²

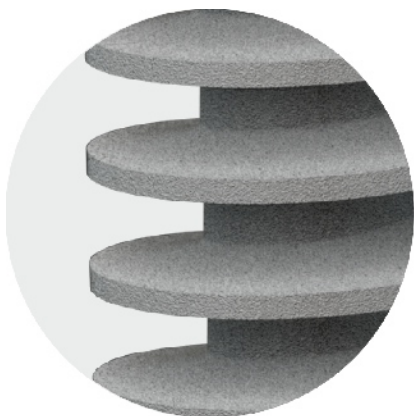

ROOTT K implant has 20-50% wider surface area than traditional two-piece or alternative ROOTT one-piece implants of the same parameters. It is essential in clinical situations where large occlusal forces are observed, especially in soft bone structures. This feature provides multi-cortical fixations, resulting in the surface area of an implant that is enlarged.

Easy management



Clinical cases



By Dr. Dainius Karpavicius

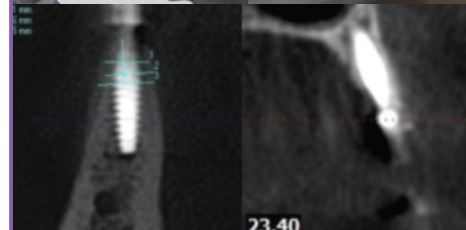

More cases



o / L	6 mm	8 mm	10 mm	12 mm	14 mm	16 mm	18 mm	20 mm
ø 3.0	C3006k	C3008k	C3010k	C3012k	C3014k	C3016k	C3018k	C3020k
øi 1.9 n 2.1	3.0 1.8 2.0 1.5 74 6.0	3.0 1.8 2.0 1.5 100 4.5	2.9 2.0 2.0 1.8 125 2.0	2.9 2.0 2.0 1.8 150 1.7	2.9 2.0 2.0 1.8 176 1.5	2.9 2.0 2.0 1.8 201 1.3	2.9 2.0 2.0 1.8 226 1.1	2.9 2.0 2.0 1.8 252 1.0
ø 3.5	C3506k	C3508k	C3510k	C3512k	C3514k	C3516k	C3518k	C3520k
øi 2.2 n 2.1	3.5 2.0 2.0 1.8 86 3.3	3.4 2.0 2.0 1.8 116 2.5	3.4 2.0 2.0 1.8 144 2.0	3.5 2.0 2.0 1.8 175 1.7	3.3 2.0 2.0 1.8 204 1.5	3.3 2.0 2.0 1.8 234 1.3	3.3 2.0 2.0 1.8 264 1.1	3.3 2.0 2.0 1.8 294 1.0
ø 4.0	C4006k	C4008k	C4010k	C4012k	C4014k	C4016k	C4018k	C4020k
øi 2.3 n 2.2	4.0 2.1 2.5 1.6 111 10.0	3.9 2.5 2.5 2.3 148 2.5	3.9 2.5 2.5 2.3 187 2.0	3.9 2.5 2.5 2.3 225 1.7	3.9 2.3 2.5 2.3 263 1.5	3.9 2.5 2.5 2.3 302 1.3	3.8 2.3 2.5 2.3 340 1.1	3.8 2.5 2.5 2.3 378 1.0
ø 4.5	C4506k	C4508k	C4510k	C4512k	C4514k	C4516k	C4518k	C4520k
øi 2.5 n 2.4	4.5 2.5 2.5 2.5 133 3.3	4.4 2.1 2.5 1.6 180 1.5	4.3 2.1 2.5 1.6 226 6.0	4.3 2.5 2.5 2.3 267 1.7	4.3 2.5 2.5 2.3 312 1.5	4.3 2.5 2.5 2.3 358 1.3	4.3 2.5 2.5 2.3 404 1.1	4.2 2.5 2.5 2.3 450 1.0

øi | øi/
øa | øa/
S | α

ROOTT **K**

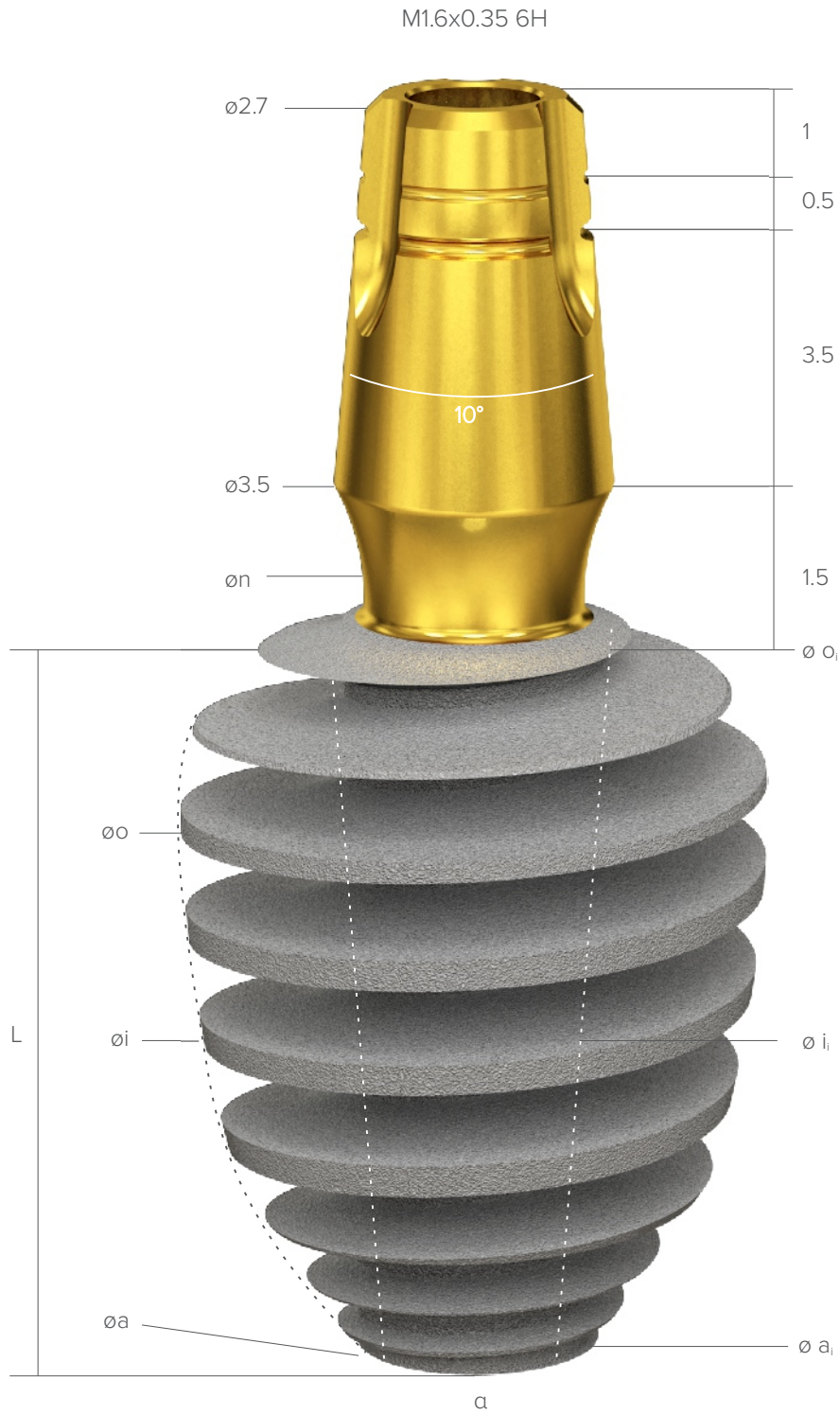

o - occlusal diameter (mm); i - intraosseous diameter (mm); a - apical diameter (mm); n - neck diameter;
 α - total internal angle (°); s - intraosseous square area (mm²); i = internal.

ø / L	4 mm	6 mm	8 mm	10 mm	12 mm	14 mm
ø 5.0	C5004k	C5006k	C5008k	C5010k	C5012k	C5014k
øi 2.7 n 2.6	4.9 2.8 2.7 2.6 104 15.0	5.0 2.8 2.7 2.6 148 13.3	4.9 2.8 2.7 2.6 202 12.5	4.8 2.8 2.7 2.6 256 12.0	4.8 2.8 2.7 2.6 304 11.7	4.8 2.8 2.7 2.6 355 11.5
ø 5.5	C5504k	C5506k	C5508k	C5510k	C5512k	C5514k
øi 2.8 n 2.5	5.4 2.8 2.7 2.6 120 15.0	5.5 2.8 2.7 2.6 176 13.3	5.3 2.8 2.7 2.6 237 12.5	5.4 2.8 2.7 2.6 298 12.0	5.2 2.8 2.7 2.6 357 11.7	5.2 2.8 2.7 2.6 416 11.5
ø 6.5	C6504k	C6506k	C6508k	C6510k	C6512k	C6514k
øi 3.1 n 2.5	6.4 3.2 3.2 3.0 150 15.0	6.4 3.2 3.2 3.0 220 13.3	6.5 3.2 3.2 3.0 299 12.5	6.3 3.2 3.2 3.0 376 12.0	6.3 3.2 3.2 3.0 451 11.7	6.2 3.2 3.2 3.0 525 11.5
ø 7.5	C7504k	C7506k	C7508k	C7510k	C7512k	C7514k
øi 3.1 n 2.8	7.4 3.2 3.2 3.0 189 15.0	7.4 3.2 3.2 3.0 283 13.3	7.3 3.2 3.2 3.0 382 12.5	7.2 3.2 3.2 3.0 476 12.0	7.1 3.2 3.2 3.0 568 11.7	7.1 3.2 3.2 3.0 662 11.5
ø 8.5	C8504k	C8506k	C8508k	C8510k	C8512k	C8514k
øi 3.1 n 2.8	8.4 3.2 3.2 3.0 232 15.0	8.4 3.2 3.2 3.0 354 13.3	8.3 3.2 3.2 3.0 479 12.5	8.1 3.2 3.2 3.0 598 12.0	8.0 3.2 3.2 3.0 713 11.7	7.9 3.2 3.2 3.0 830 11.5

øi | øii
øa | øai
S | α

Titanium abutments for telescopic fixation



Healing abutments

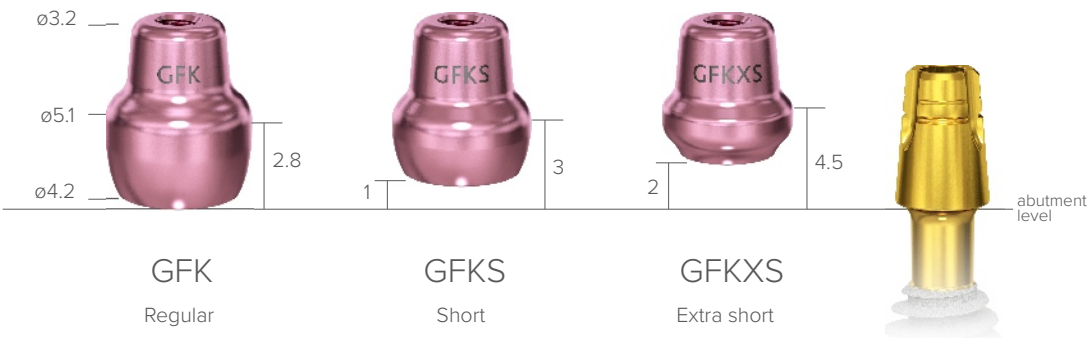

Transfers



Analogs

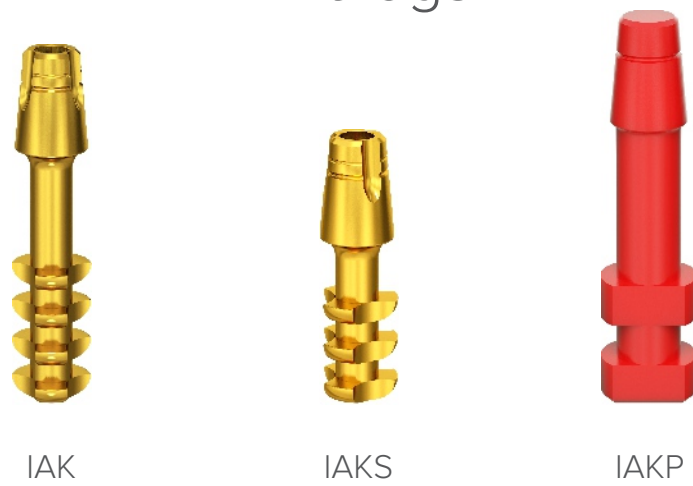

Prosthetic screws

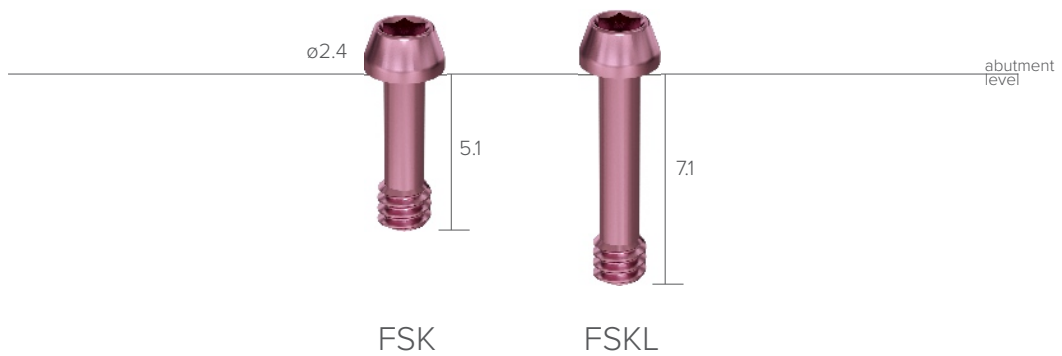

One-piece abutment

Cover screw

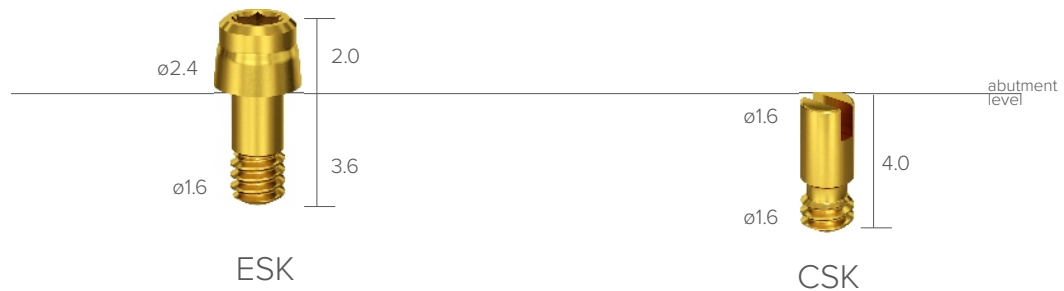

Temporary abutments

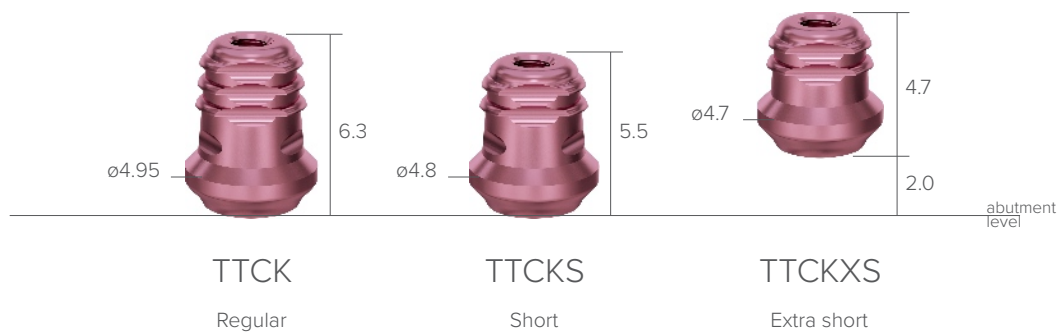

Burn-out abutments



BOCK
Regular



BOCKS
Short

Instruments

Drills

Lance drill



Twist drills



Universal drills



ROOTT R



ROOTT C



ROOTT B



Taps

ROOTT **R**



ROOTT **C**



Universal taps



Handles



ETH

Surgical handle, handpiece

ETR

Surgical handle, ratchet



ETAO

Surgical handle, AO



DW

Handle for implant driver

Gauges

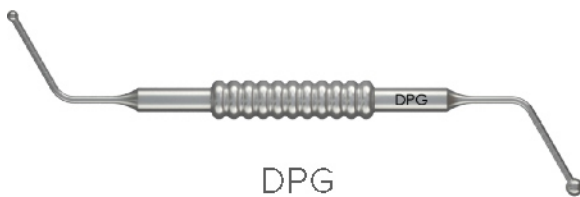

DPG

Implant depth gauge



DIR

Alignment bar



P2

Parallel pin

Screwdrivers



SD SDL SDXL SDLB SDXLB SDH SDHL SDHXL SDAO SDM SDML

Ball hex Ball hex

For ratchet

For handpiece

For AO handle

Manual

Implant drivers

ROOTT^R

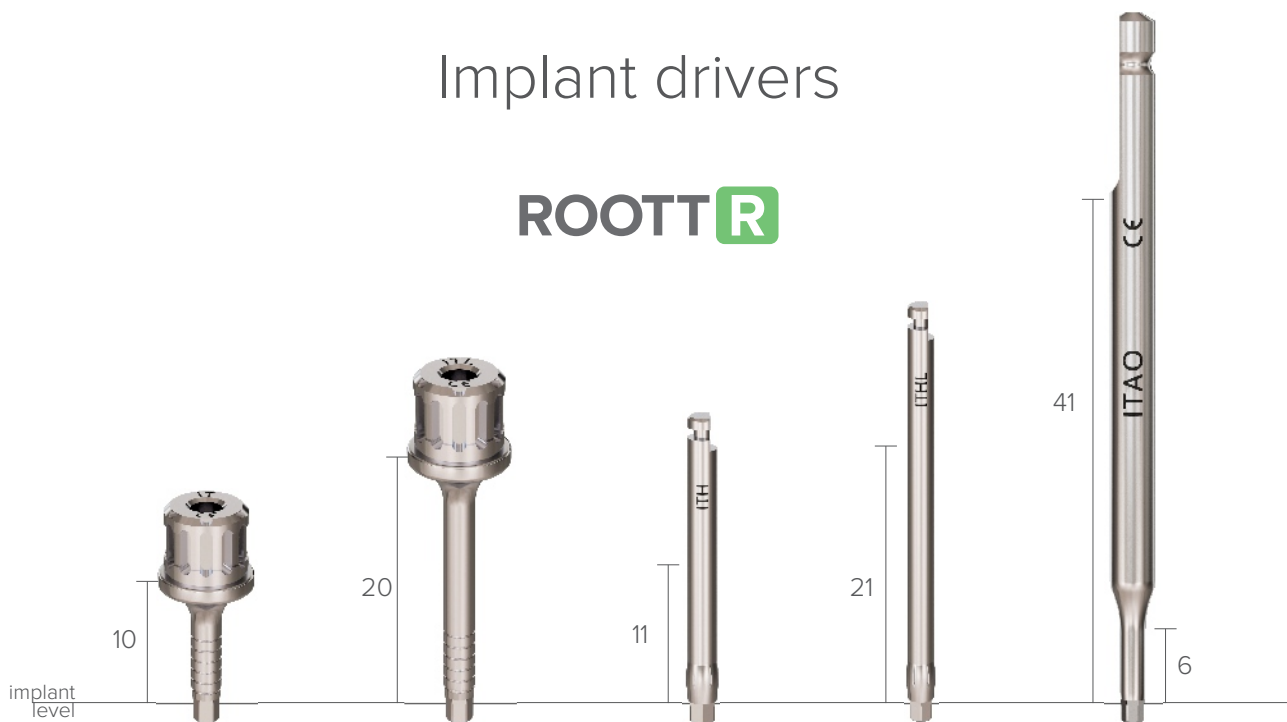

IT

ITL

ITH

ITHL

ITAO

For ratchet

For handpiece

For AO handle

ROOTT C CS B BS



ROOTT M P

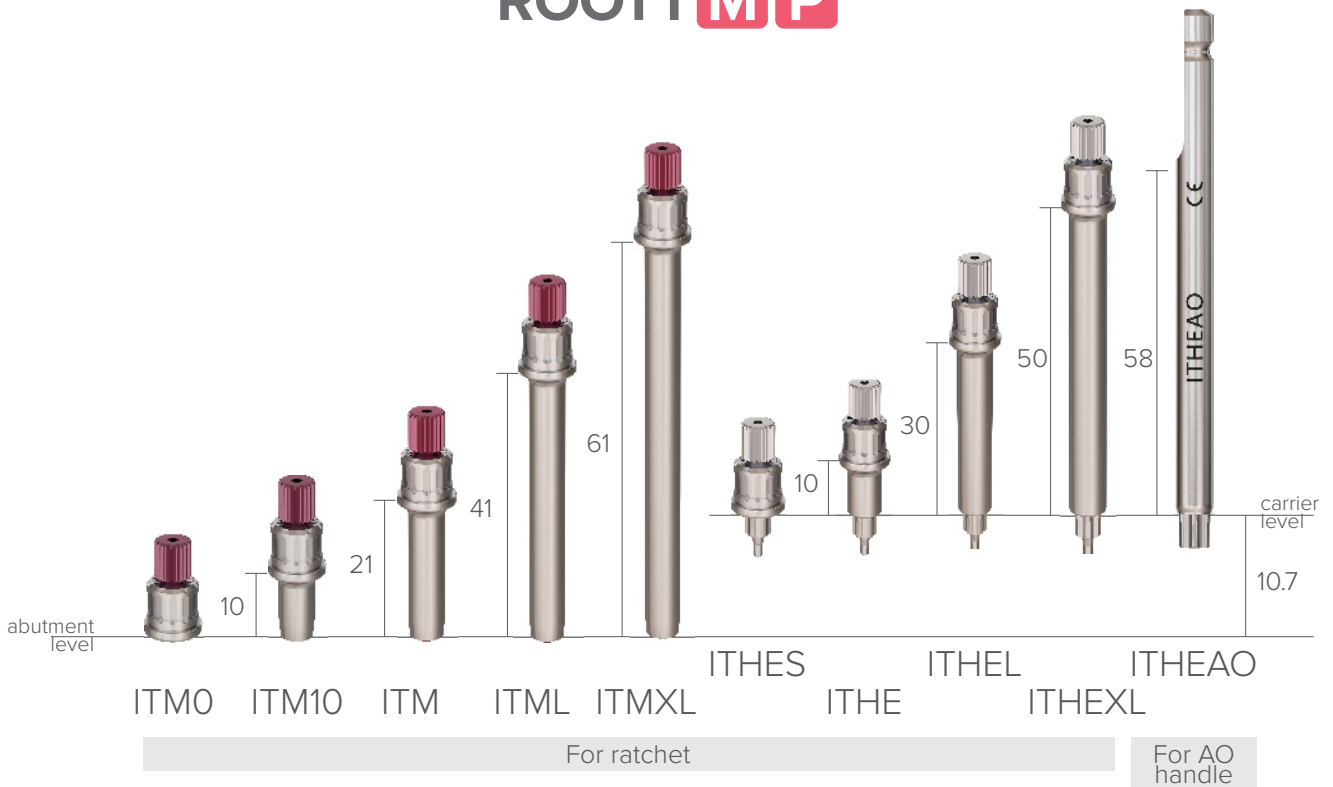

ROOTT **S**

ROOTT **M P**

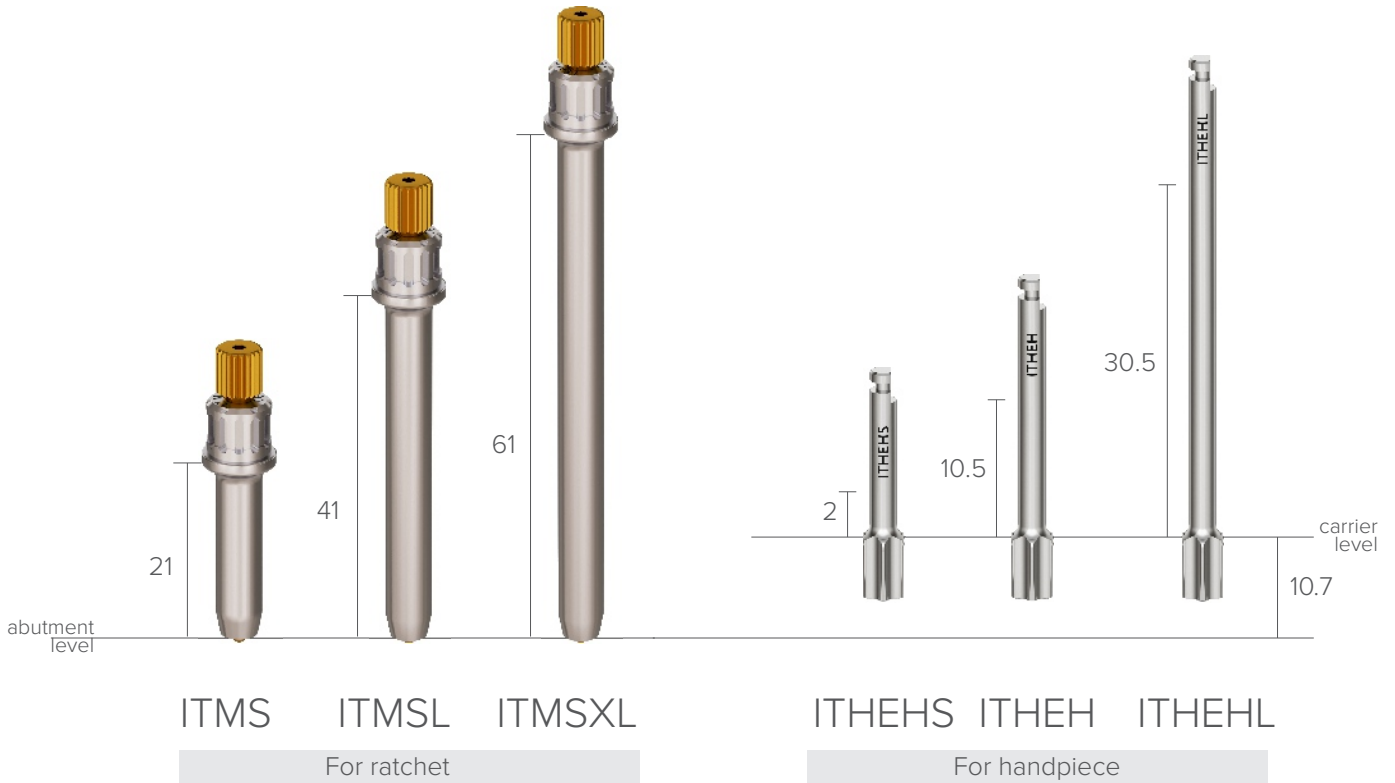

ROOTT **K**

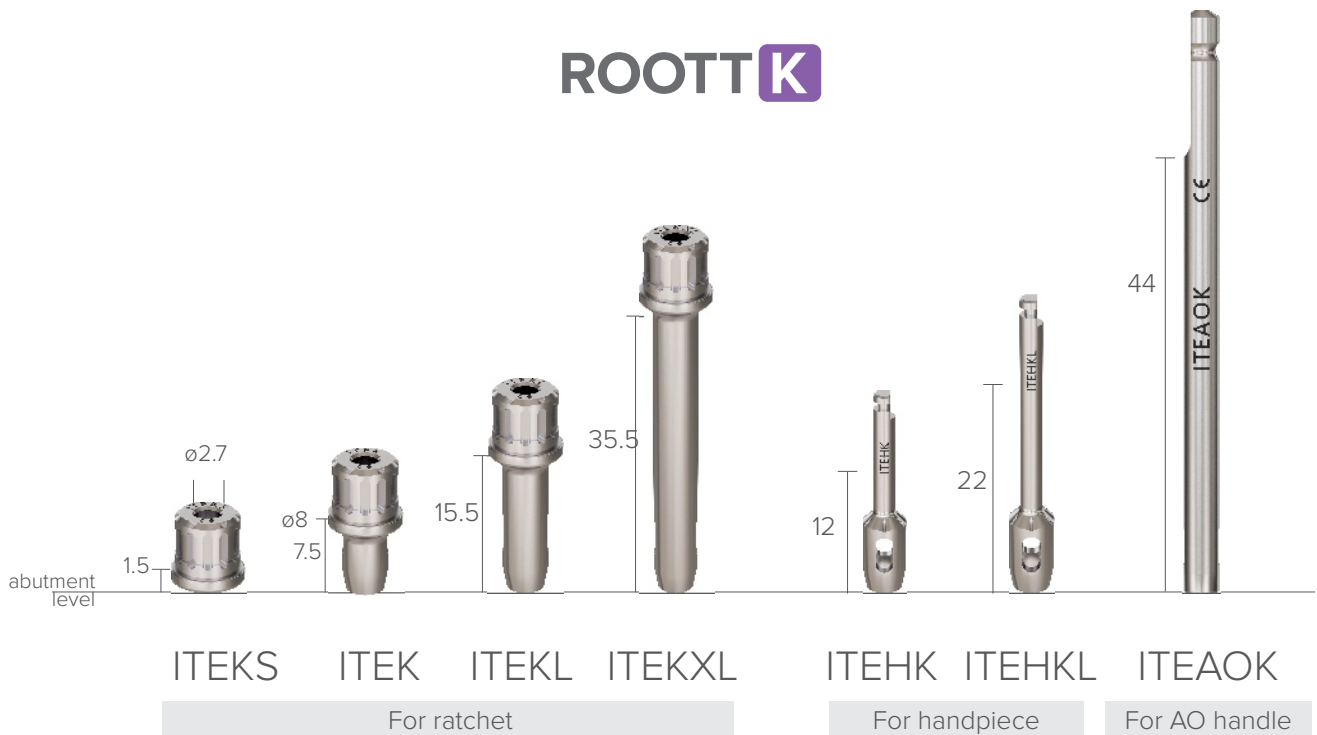

General instruments



TW50
Torque wrench 10-50 Ncm



TW70
Torque wrench 10-70 Ncm



RW, RWS
Ratchet wrench



BT
Abutment bender for ROOTT **C** **B** **BS**



BTK, BTKL
Abutment bender for ROOTT **K**



ET
Drill extension for handpiece



ETAO
Drill extension for AO handle

Abutment extractors



SR, SRL
Abutment extractors for ROOTT **R**



PRT
Abutment extractor for ROOTT **K**



PRS
Abutment extractor, screwdriver for ROOTT **K**

Guided system

Stoppers



Stoppers S1 compatible with drills
DB2020, D2020, D2516, D2816,
DC3006.....DC4520

S1L02 S1L04 S1L06 S1L08 S1L10 S1L12 S1L14 S1L16



Stoppers S2 compatible with drills
D3216, D3616, D4016, D4316,
DC5006.....DC5514

S2L02 S2L04 S2L06 S2L08 S2L10 S2L12 S2L14 S2L16



Stoppers S3 compatible with drills
D4616, D516, D5316

S3L02 S3L04 S3L06 S3L08 S3L10 S3L12 S3L14 S3L16

Sleeves and drills handles



SL02 SLS1 SLS2 SLS3

A02SL3 A02SL2 A02SL1

A1SL3 A1SL2

A2SL3

2Ingis system

Punches

	D3024 ø 3 mm
	D4024 ø 4 mm
	D4029 ø 4 mm
	D5024 ø 5 mm

Mills

	D2824 ø 2.8 mm
	D2829 ø 2.8 mm
	D2834 ø 2.8 mm
	D3524 ø 3.5 mm
	D4124 ø 4.1 mm

Self drilling screw



S1415

Cassettes



Manual



TRS **R C C S M S**

A large surgical kit tailored for experienced specialists seeking a versatile solution to address multiple clinical scenarios and implant procedures. This flexible kit offers a convenient bundle of tools that effectively cater to clinicians' needs.



Manual



TRS-mini **R C C S M S**

TRS-mini is an ideal choice for specialists who are looking for a compact and lightweight surgical implant kit that covers most scenarios. It includes essential tools such as implant drills, basic drivers, an abutment extractor, and a ratchet, providing a comprehensive response to your individual needs.

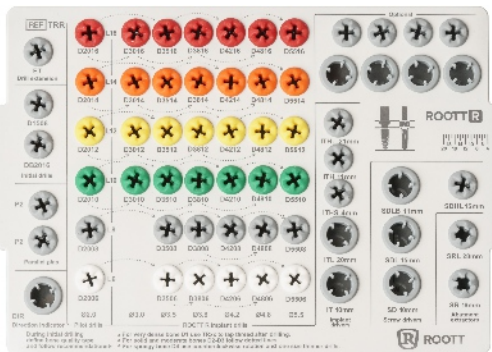

TRR **R**

A large surgical kit tailored for experienced specialists working with ROOTT R implants. With a simplified protocol and increased efficiency through reduced drilling steps, this kit enhances the overall implantation process.



Manual



TRR-mini **R**

TRR-mini kit offers a hassle-free solution which is designed for specialists working with ROOTT R implants. It features ultra-sharp drills in various lengths, enabling effortless and immediate implant placement. With a simplified protocol and increased efficiency through reduced drilling steps, this kit enhances the overall implantation process.

Prosthetic workflows

ROOTT **R**

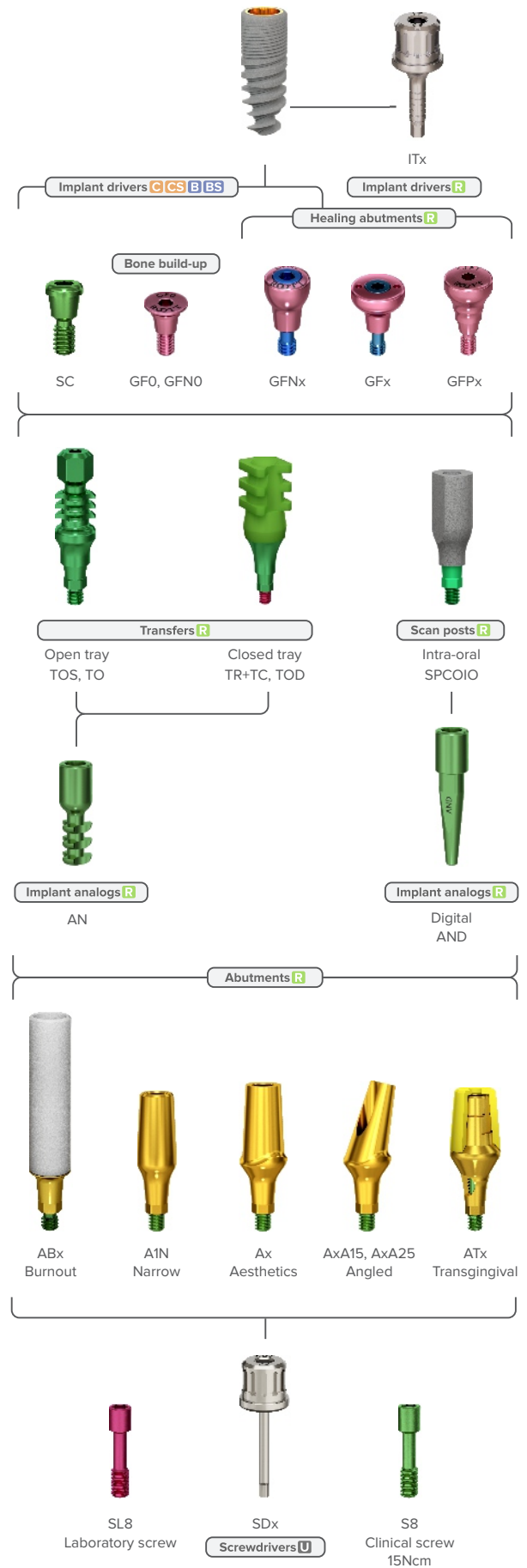

ROOTT R

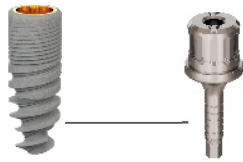

ITx

Implant drivers **C CS B BS**

Implant drivers **R**

Healing abutments **R**

Bone build-up



SC

GF0, GFN0

GFNx

GFx

GFPx



Transfers **R**

Open tray
TOS, TO



Closed tray
TR+TC, TOD



Scan posts **R**

Intra-oral
SPCOIO



Implant analogs **R**

AN

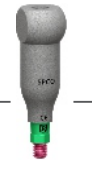

Scan posts **R**

Laboratory
SPCO



Implant analogs **R**

Digital
AND

Abutments **R**



PMAB
Blanks



PCOx, PCoXS



PCOR, PCORS



PCO

Titanium base



SL8
Laboratory screw



SDx
Screwdrivers **U**



S8
Clinical screw
15Ncm

ROOTT R



ITx

Healing abutments **R**

Bone build-up



SC

GF0, GFN0

GFNx

GFx

GFPx



Transfers **R**

Open tray
TOS, TO



Closed tray
TR+TC, TOD



Scan posts **R**

Intra-oral
SPCOIO



Implant analogs **R**

AN



Scan posts **R**

Laboratory
SPCO



Implant analogs **R**

Digital
AND

Abutments **R**



Mx



MxA15



MxA30



MxA45

Abutments **M P**



AM
Regular



ABMUA
Burn out
Angled



ABMU
Burn out



PCOM
Titanium base



SFPCOML
Laboratory screw



SDx
Screwdrivers **U**



SFPCOM
Clinical screw
15Ncm

ROOTT R

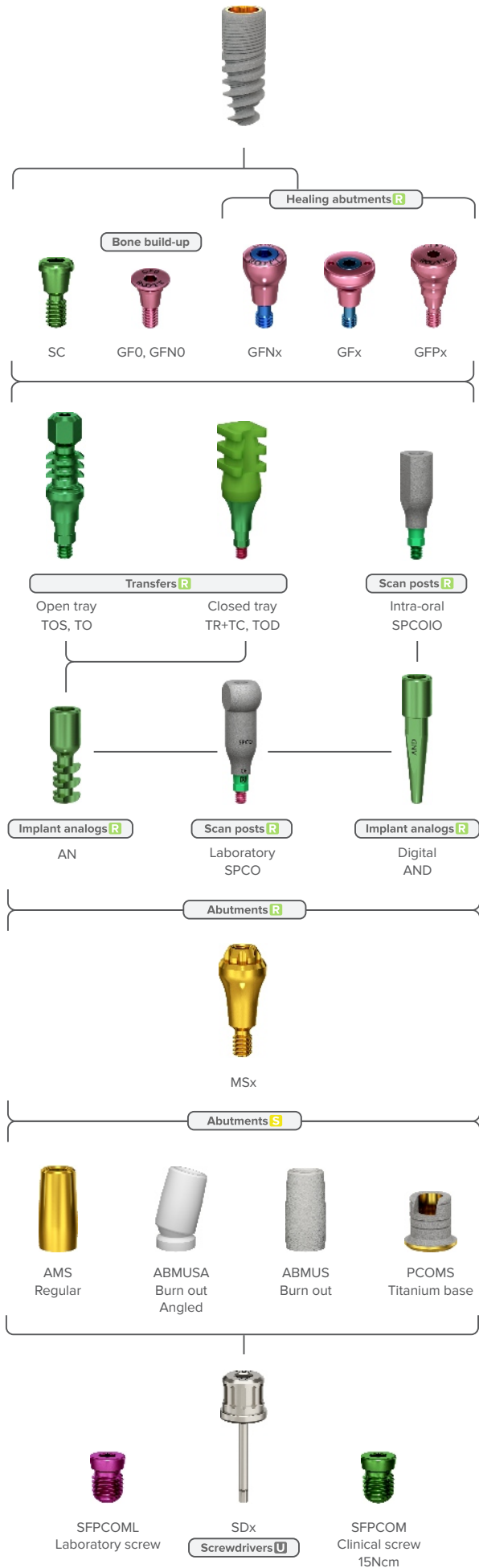

ROOTT R

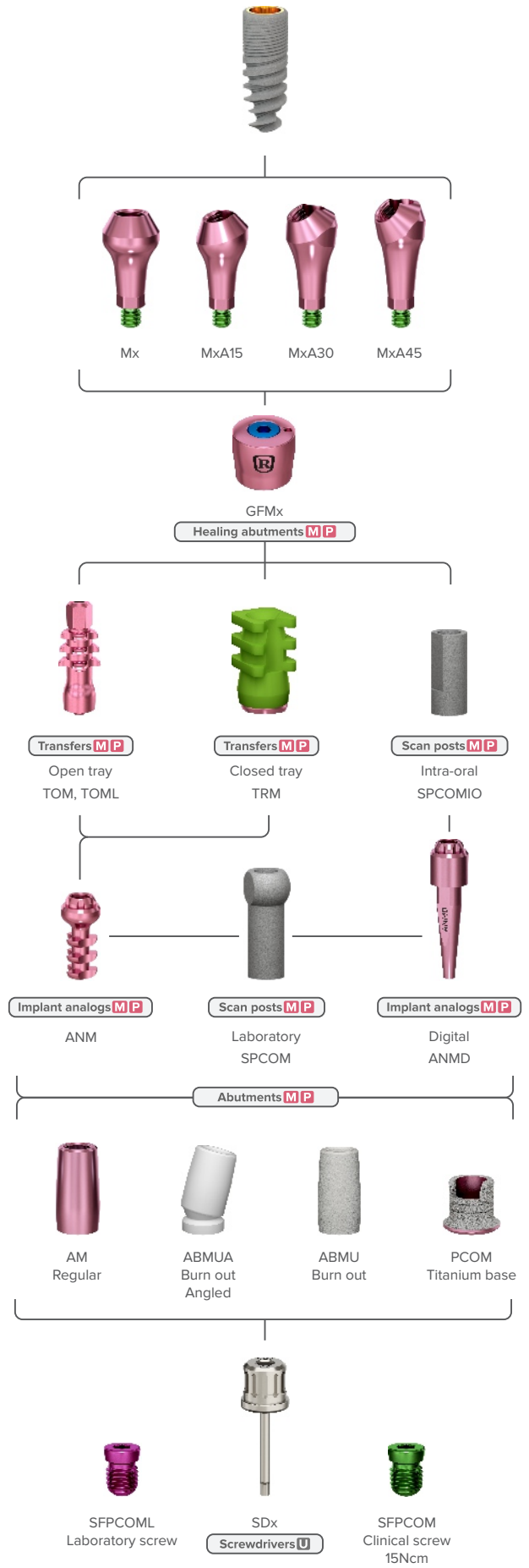

ROOTT R

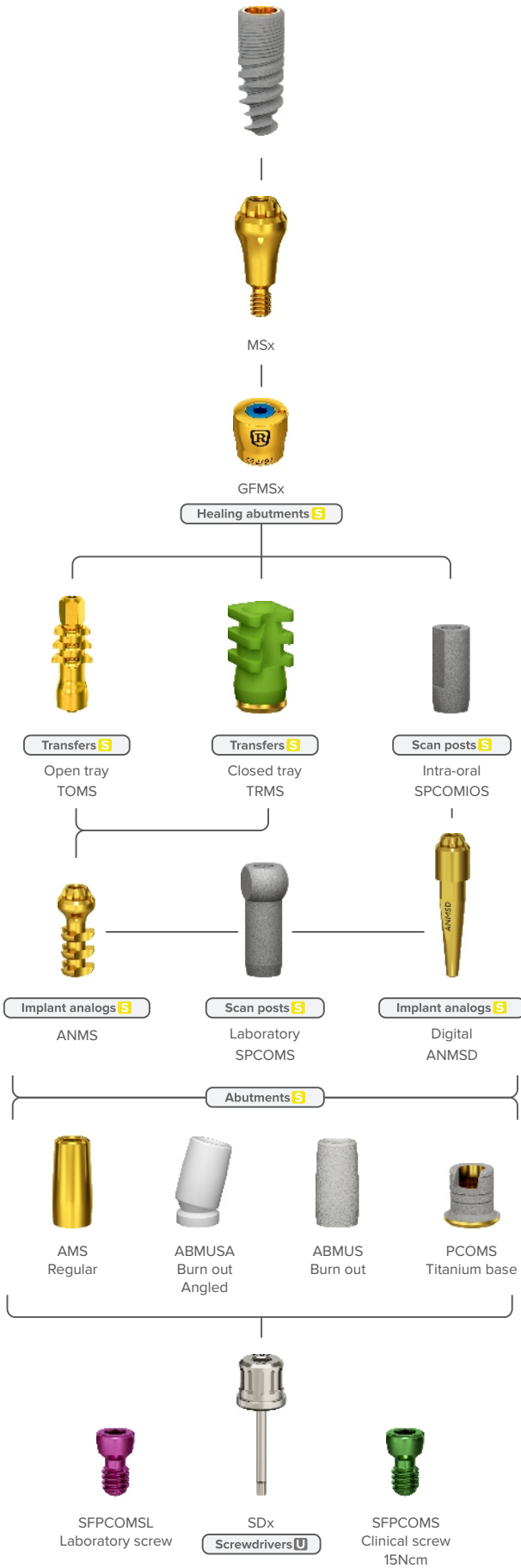

ROOTT C CS

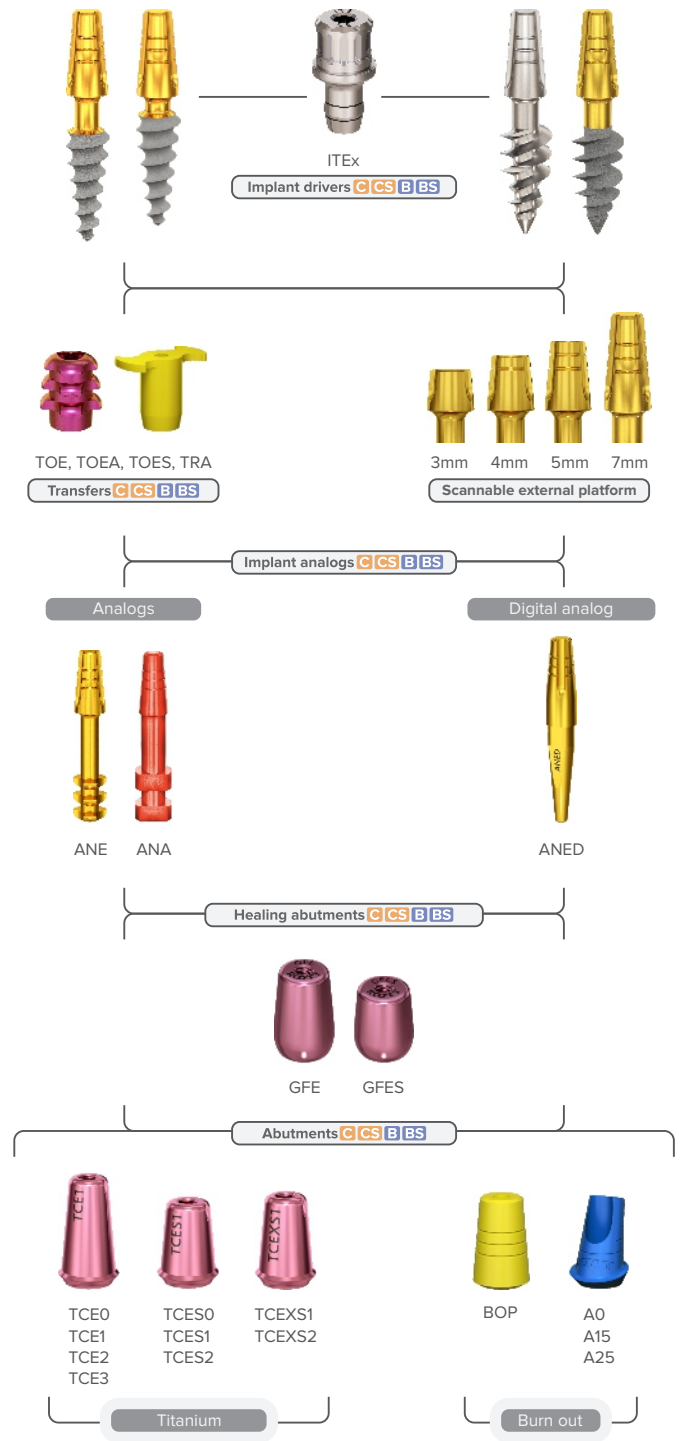

ROOTT M

ROOTT P

ROOTT S

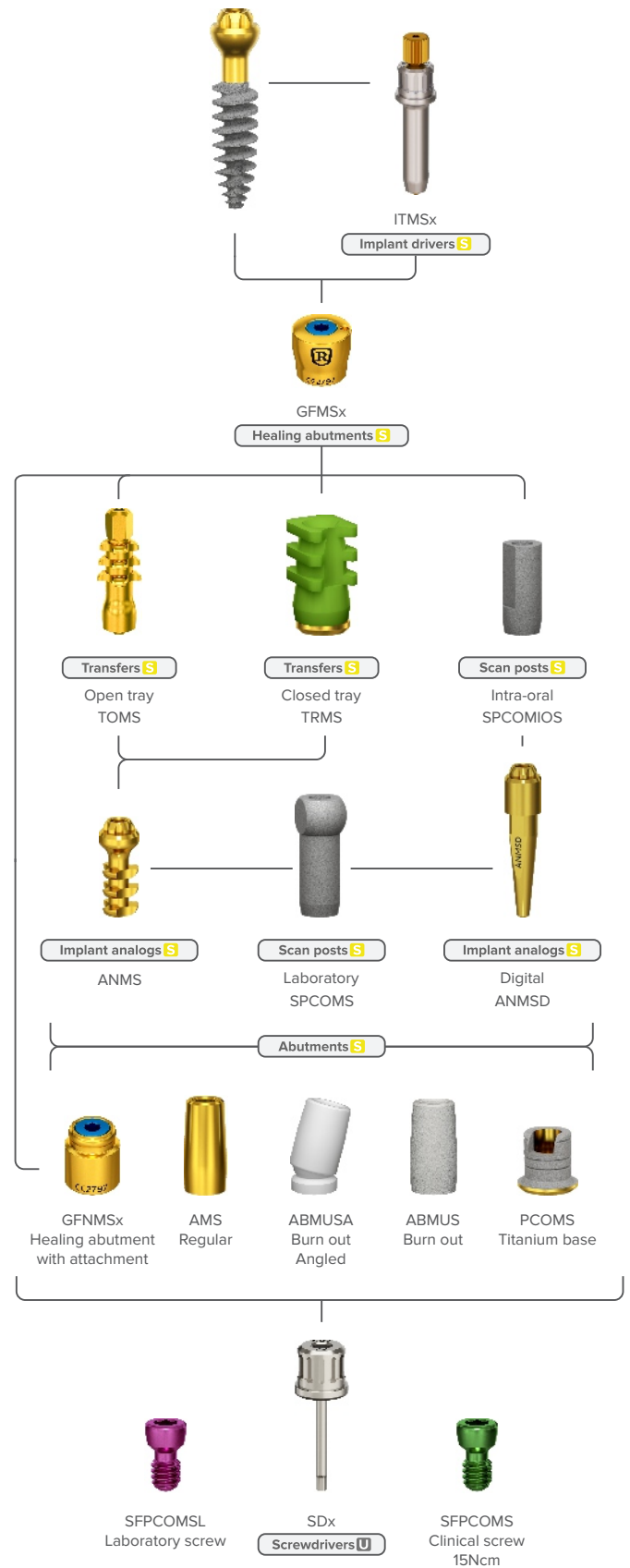
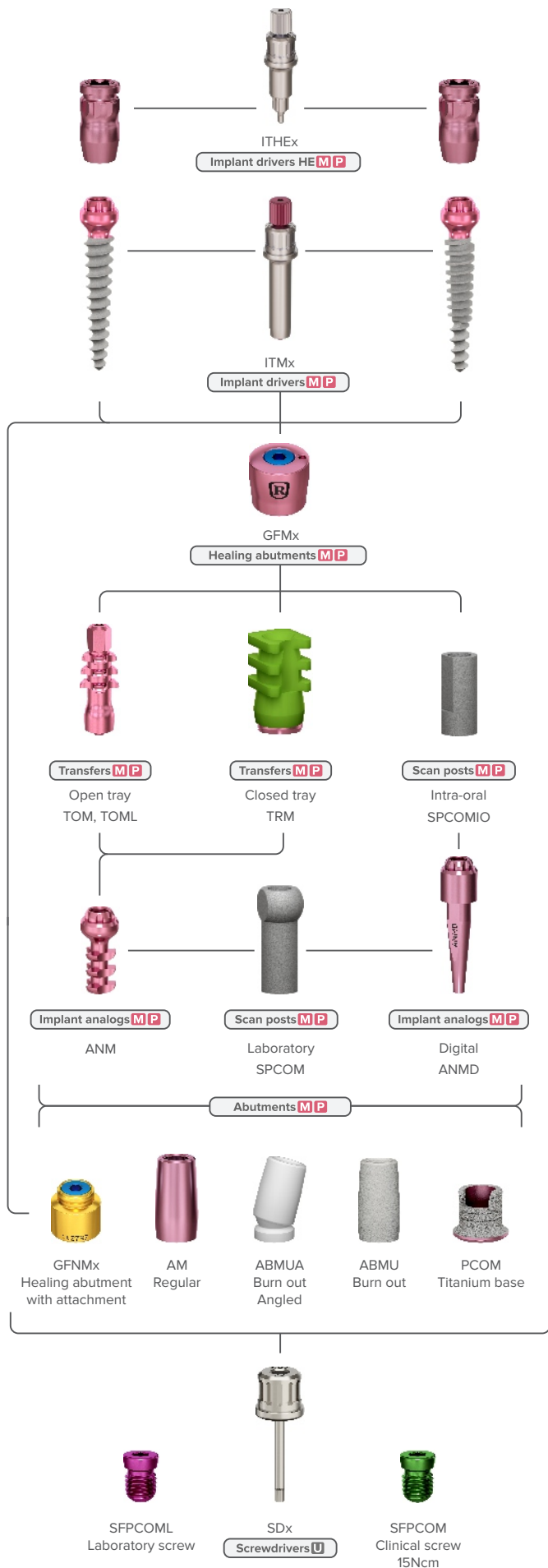

Meet the intelligence with DIGITAL SOLUTIONS

Time-efficient and accurate options enhance quality possibilities and bring the modern approach to the dental industry that dental professionals seek.

Precision is essential considering the right angle, size, depth and width for dental professionals; therefore, ROOTT offers the digital workflow allowing the possibility of designing a complete dental solution. The digital library will provide options and introductions into using software and transferring the skills into the digital workflow from the tools required to design the exterior to components offered to solve basic or complex cases.



ROOTT
digital
libraries



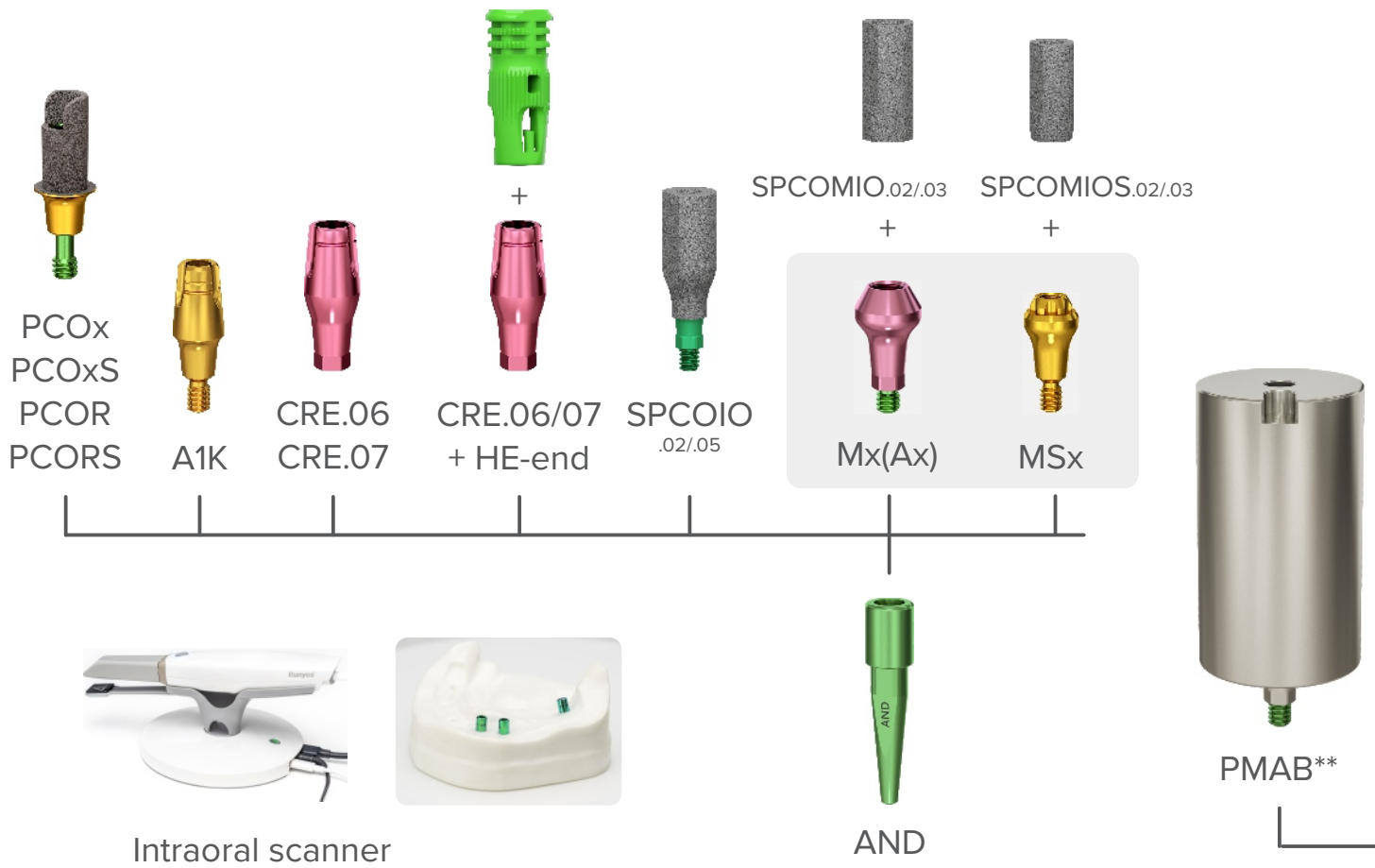

Scan/Impression

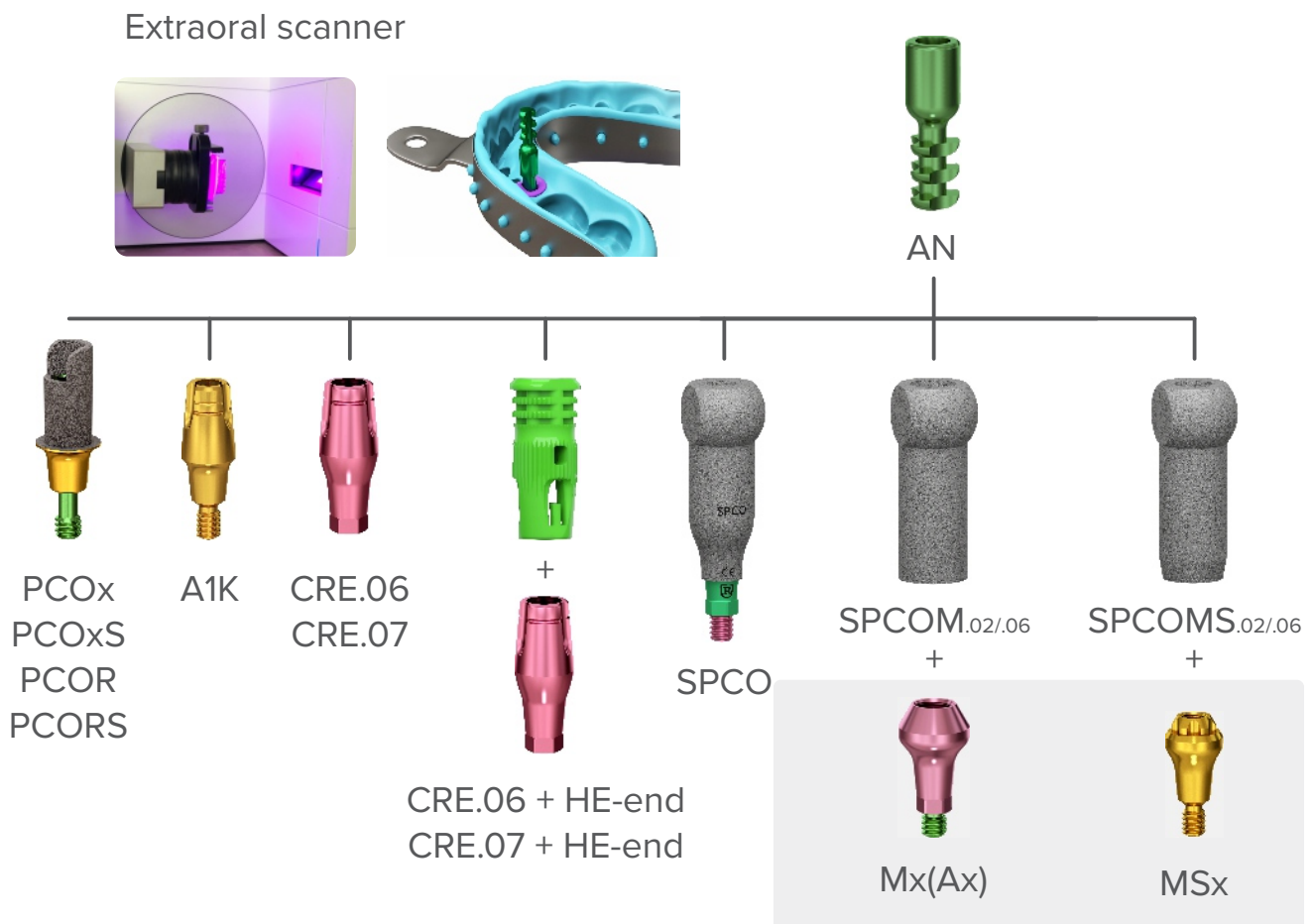

Digital workflow **ROOTT**^R

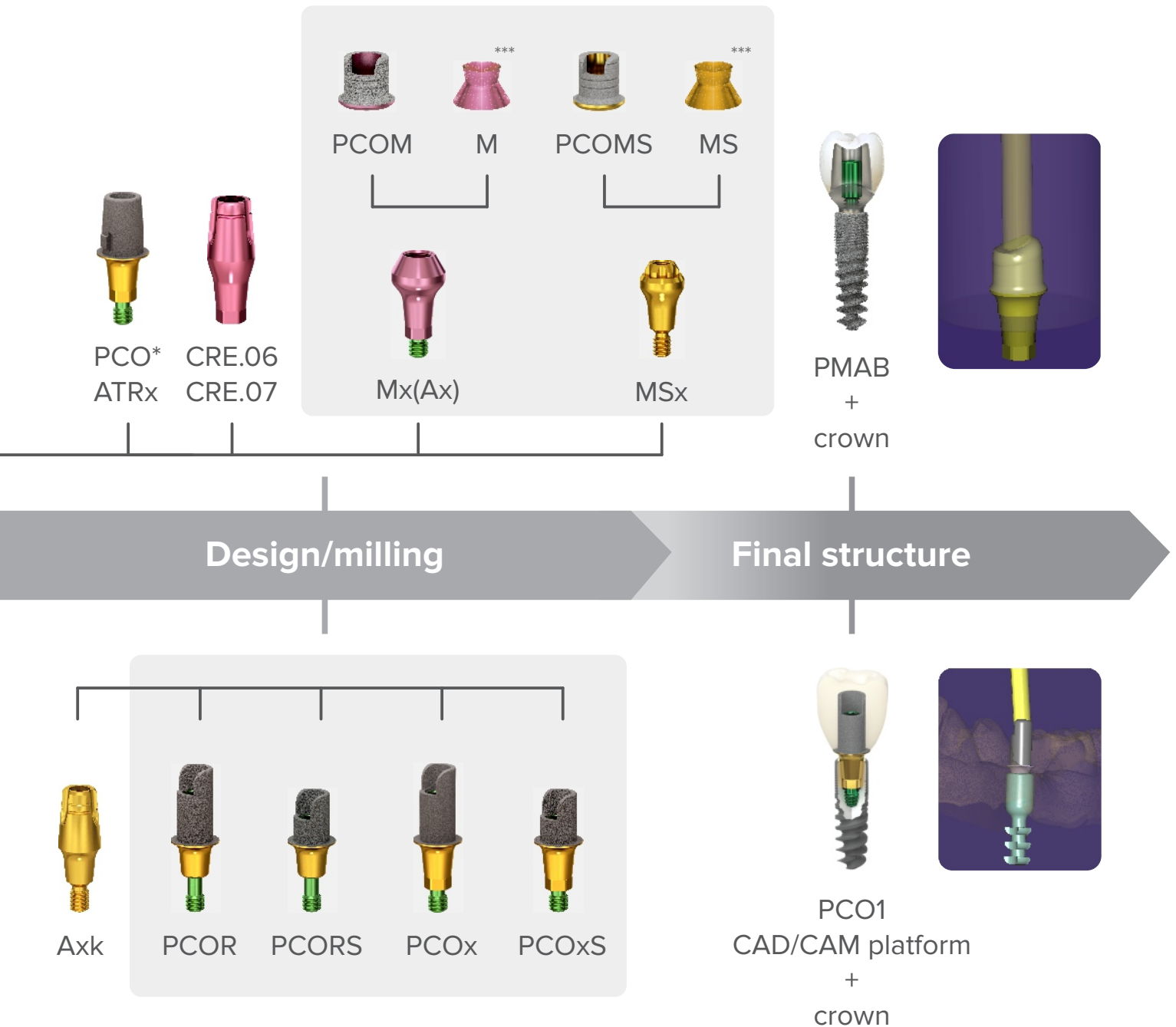

* Cerec part for Sirona

** Premilled abutment blank

*** MU abutment is only accessible in digital library with angulation option and used with SFPCOMS screw for MS1, SFPCOM screw for M1

Abutments in the light grey background are angulated from 0° to 20° and are easily handled with an SDLB screw driver.



ANED



TRA



TOES



TOEA



TOE



HE



7mm



5mm



4mm



3mm

External platform



TCE
TCES
TCEXS

Intraoral

Scan/Impression

Extraoral



ANE



ANA



TRA



TOES



TOEA



TOE



HE



7mm



5mm



4mm



3mm

External platform



TCE
TCES
TCEXS

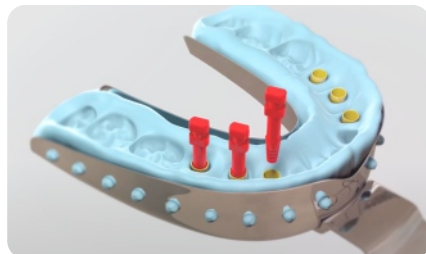

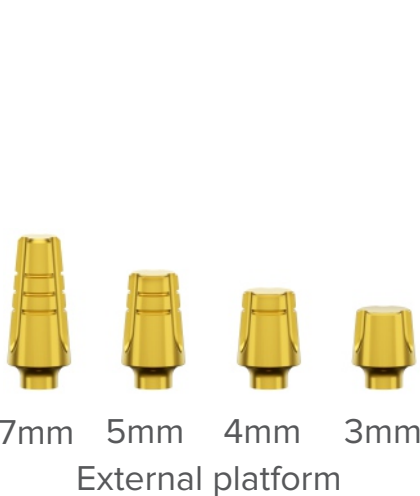

Metal framework

Prosthesis with cement

Design/milling

Final structure

Telescopic abutments
External platform

Prosthesis with
telescopic solutions



+



TCE
TCES
TCEXS



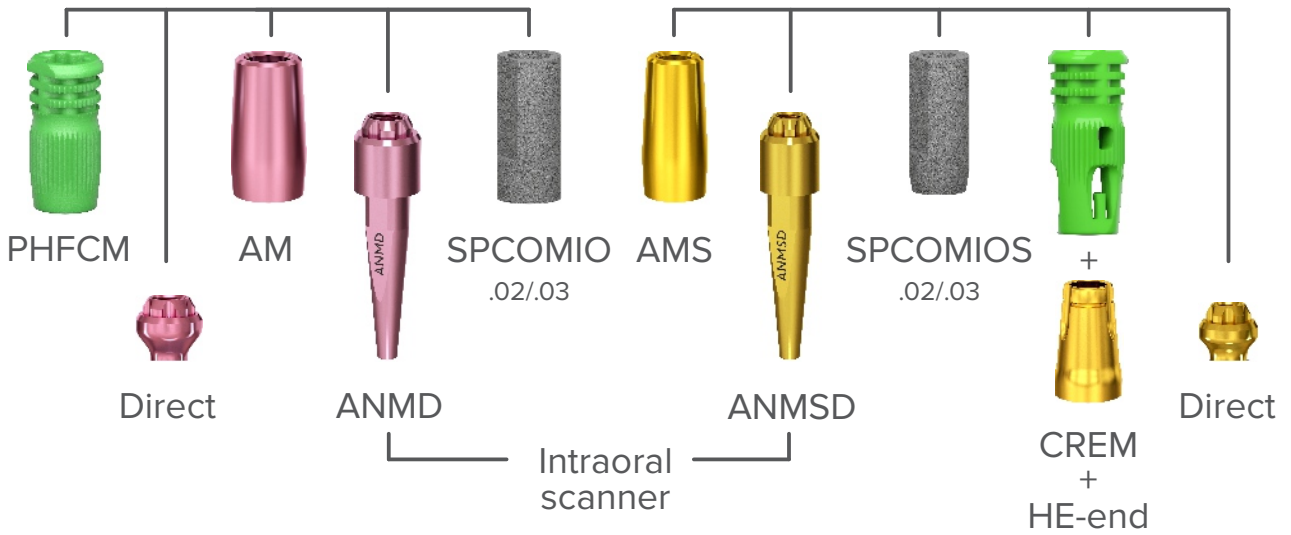
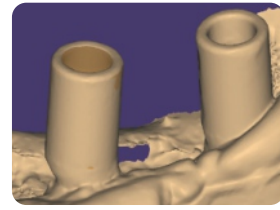
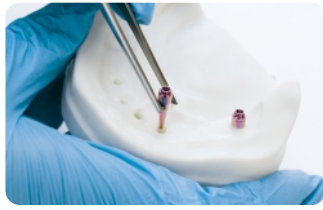

Scan/Impression

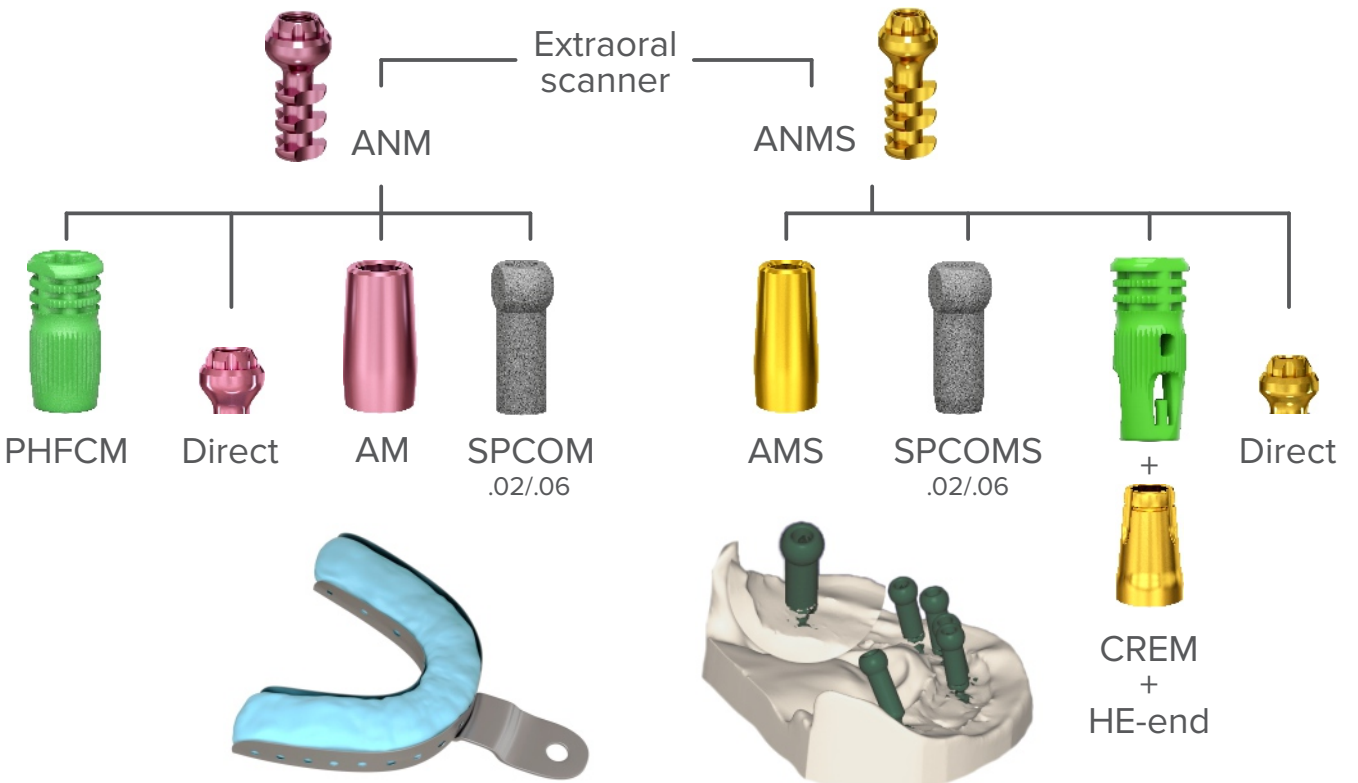

Digital workflow **ROOTT M P S**

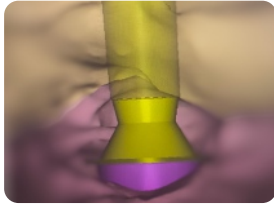

MU digital abutment *



Metal Framework

Design/milling

Final structure

PCOM

PCOMS



PCOM

PCOMS

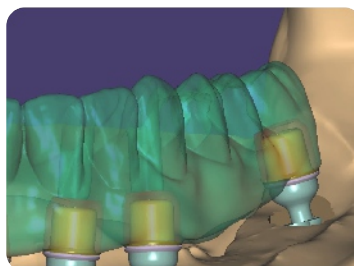
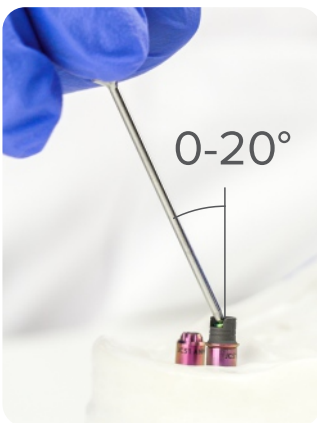

* MU abutment is only accessible in digital library with angulation option and used with SFPCOMS screw for ROOTT S, SFPCOM screw for ROOTT M/P.

Together with specialists for standards that matters

ROOTT has always sought excellence and reliability by utilizing innovative approaches and solutions right from the design stage. Since its foundation, ROOTT has put research and cutting-edge innovation at the forefront of its mission. This is the result of diligent, dedicated work and close cooperation with the Open Dental Community (Luxembourg) – an independent, international team of expert dentists and academic professionals, which provides a significant link between industry and dental professionals.

ROOTT never compromises on functionality and simplicity dedicated to dental professionals.

Simplicity

Built with profound knowledge and insight of what is necessary for practitioners to achieve perfection in their successful clinical practice.

Functionality

To ensure functionality and flexibility every product is probed, diligent and dedicated for every specialist need. Each and every single piece of product is created with the research of doctors.



Innovations and development network of dental specialists around the world.
Life learning concept and constant improvement of global dental knowledge and skills.



70+

distributors

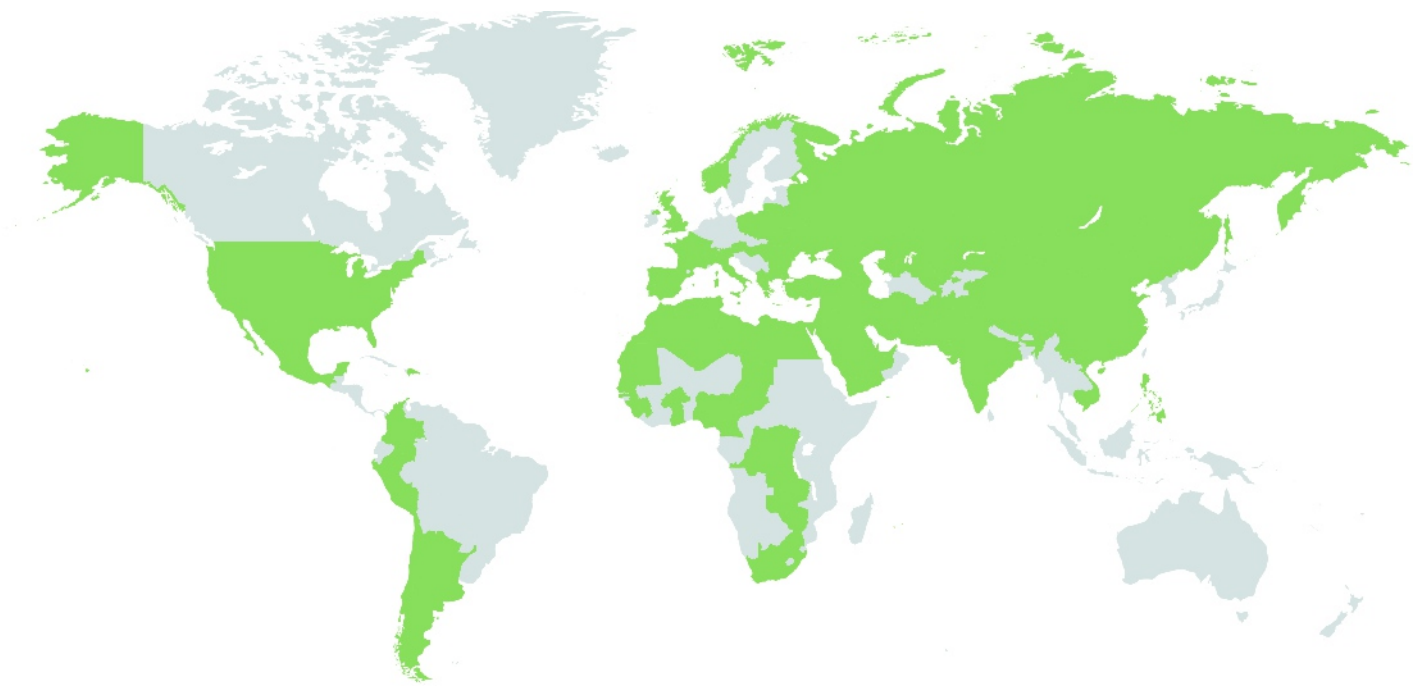

Products
& events

roott.ch



Clinical
cases

opdeco.org



+41 41 450 01 01
info@trate.com
roott.ch



 **TRATE UAB**
Jonavos st. 254
44110 Kaunas
Lithuania

 **TRATE AG**
Bahnhofstrasse 16
6037 Root
Switzerland